

Planning Scheme Policy Neighbourhood Design



Table of Contents

Adoption	3
Commencement	3
Amendment	3
1 Introduction	3
1.1 Purpose	4
1.2 Application	4
1.3 Structure.....	4
2 Site Analysis and Conceptual Design.....	6
2.1 Site Analysis	6
2.2 Outline Plan	8
2.3 Refining the Layout	9
3 Neighbourhood development plans	11
3.1 Introduction	11
3.2 NDP areas	11
3.3 NDP preparation process	13
3.4 Planning elements to consider when preparing a NDP.....	14
4 Density.....	20
4.1 Definition.....	20
4.2 Measuring Density.....	21
4.3 Converting between Site Density and Net Residential Density.....	22
5 Housing Diversity.....	23
5.1 Lot Types and Lot Mix.....	24
6 Street Design and Layout.....	28
6.1 Grid Structures.....	28
6.2 Block Dimensions.....	30
6.3 Connecting to the existing and future street network	31
7 Integration Plans	34
8 Street Hierarchy	36
8.1 Street Hierarchy and Structure.....	37
8.2 Local Street Types	38
8.3 Intersection Types and Spacing	39
9 Orientation of Streets.....	41
10 Limited Access Streets	43
11 Street Layout and Design.....	47

12	Open Spaces	49
12.1	Parks	49
12.2	Stormwater.....	52
12.3	Green Infrastructure Network.....	53
13	Centres	56
14	On-Street Parking	58
15	Transitions between Precincts and Zones.....	60
15.1	Next Generation to Urban.....	60
15.2	Neighbourhood Hubs.....	60
16	Enterprise and Employment Areas	62
16.1	Purpose and Character	62
16.2	Location	63
16.3	Structure.....	64
16.4	Movement.....	65
16.5	Stormwater.....	66
16.6	Open Space and Facilities.....	67
16.7	Retention of High Value Vegetation	68
16.8	Transitions to Other Zones	69
	End Notes	70

Adoption

Moreton Bay Regional Council adopted this planning scheme policy on 24 November 2015.

Commencement

This planning scheme policy will take effect from 1 February 2016.

Amendment

Alignment amendment 1 2017

- Adopted by Moreton Bay Regional Council on 27 June 2017
- Took effect from 3 July 2017

Major amendment 1 2019

- Adopted by Moreton Bay Regional Council on 12 December 2019
- Took effect from 29 January 2020.

1 Introduction

This policy supports the Moreton Bay Regional Council Planning Scheme and has been made by Council in accordance with Chapter 2, Part 3, Division 2 of the Planning Act 2016.

The MBRC Planning Scheme emphasises the importance of place making and urban design to create attractive and liveable neighbourhoods. This is particularly important as the scheme seeks to accommodate more people and jobs within new and existing urban areas.

All new development will be planned, designed and delivered to a high standard, to respect and respond to local conditions, including:

- Connections to existing facilities and local movement networks;
- Flood hazards;
- Environmental networks;
- Physical features;
- The local market;
- Cultural heritage; and
- Views and vistas.



1.1 Purpose

The purpose of this policy is to:

1. Provide a guide for the design of reconfiguring a lot applications which achieve the outcomes of the applicable parts of the planning scheme.
2. Provide guidance to the information required when submitting development applications.
3. Identify the key attributes of neighbourhood planning.

1.2 Application

This policy applies to:

- a) All reconfiguring a lot applications proposing more than 1 additional lot.
- b) Residential Uses applications on sites with an area greater than 6,000m².



1.3 Structure

This guide is in three parts:

Part 1 - Site Assessment and Conceptual Design

Describes the process of design, from site analysis through to lot layout. It illustrates how proposals should respond to the site and its surroundings.

Part 2 - Residential Areas

Elaborates on the Performance Outcomes described in the MBRC Planning Scheme. It illustrates good practice in the design of residential areas and associated centres and shows some of the ways to achieve compliance with the scheme.

The matters are addressed in the order they appear in the scheme, in the various precincts in the General Residential and Emerging Community zones. Note that the matters always appear in the same order in the scheme, although the PO numbers are not always the same. A table is provided in each section to show the applicable PO's in each precinct.

Part 3 - Employment and Enterprise Areas

Elaborates on the Performance Outcomes for the various Industrial Zone precincts and shows some of the ways to achieve compliance with the scheme.



PART 1

**SITE ASSESSMENT
and
CONCEPTUAL DESIGN**

2 Site Analysis and Conceptual Design

2.1 Site Analysis

A comprehensive analysis of the site and its surroundings should be undertaken before the layout is designed. Each site is unique and will require its own unique approach to development. The site layout must be designed around the unique features of the site and its surroundings.

The first stage is to map the significant features of the site. Some of the matters that will need to be considered are outlined below. Council may request an applicant to demonstrate that appropriate site analysis has been undertaken as part of the Reconfiguring a lot application.



Figure 1: Example of a site analysis

Items to Include in a Site Analysis

Site Features

- Location of mature trees
- Contours and changes of level
- Orientation of site
- Any Unstable or contaminated land
- Prevailing winds
- Water courses, creeks and floodable land
- Cultural Heritage

Green Infrastructure Network (GIN)

- Areas of environmental significance and corridors (refer to Planning scheme policy – Environmental areas and corridors)
- Koala vegetation and movement patterns
- Habitat for native fauna
- Vegetation that will need to be offset if cleared

Surrounding Activities

- Adjoining zoning now and future intent
- Adjoining existing land use
- Adjoining development interface – eg fencing and whether lots front onto or back onto the site.
- Location of focal points (schools, community facilities, shops, public transport, etc)
- Open outlooks and views

Movement Patterns

- Pattern of roads, walkways and parks within site and on adjoining site. This should identify all points of connection to the site.
- Transport routes including arterial roads, highways and public transport routes that would serve the development.
- Existing and potential access points, including intersection spacing.
- Existing and desired pedestrian and cycling routes
- Bus routes and public transport
- Walkable catchments of rail stations (800m radius circle of the station)
- Limited Access Roads
- Condition and formation standard of existing roads

Open Space and Stormwater

- Access to open space.
- Overland Flow paths, creeks etc
- The need for on site management of stormwater

Infrastructure

- Existing sewage and water infrastructure
- Easements
- Other infrastructure (e.g. power lines, gas, telecommunications)

2.2 Outline Plan

The development must have an overarching structure that responds to its surroundings and the matters identified in the site plan. Developments must take advantage of the unique characteristics of their site and also be part of the structure of the town in which they are located.

An outline plan shows how to respond to the site characteristics and guides the development of the urban structure. It demonstrates how the neighbourhood will function as part of a wider urban area.

The analysis should identify routes to and through the site along desire lines. The aim should be to connect the development in with its surroundings and to provide direct connections through the site, particularly to obvious nodes such as neighbourhood hubs or public transport.

The road hierarchy through the site should be identified at this stage. The roads identified below act as a framework for access and a starting point. Once the major roads have been identified, the minor roads can be structured around them.



Outline plan responding to site analysis

2.3 Refining the Layout

Drawing a layout plan is an iterative process as all the different layout considerations must be taken into account. Making changes to one aspect of the design (such as the position of a park) will affect how the neighbourhood functions, and require subsequent changes to other aspects of the design (e.g. the road layout).

Once an initial layout plan has been devised, it should be refined to ensure that it works for the type of development expected. Consideration should be given to matters such as the size and orientation of blocks, development densities and street types, as shown on the diagrams that follow.

These are the matters described in Part 2 of this guide.



Layout refinement - road typologies

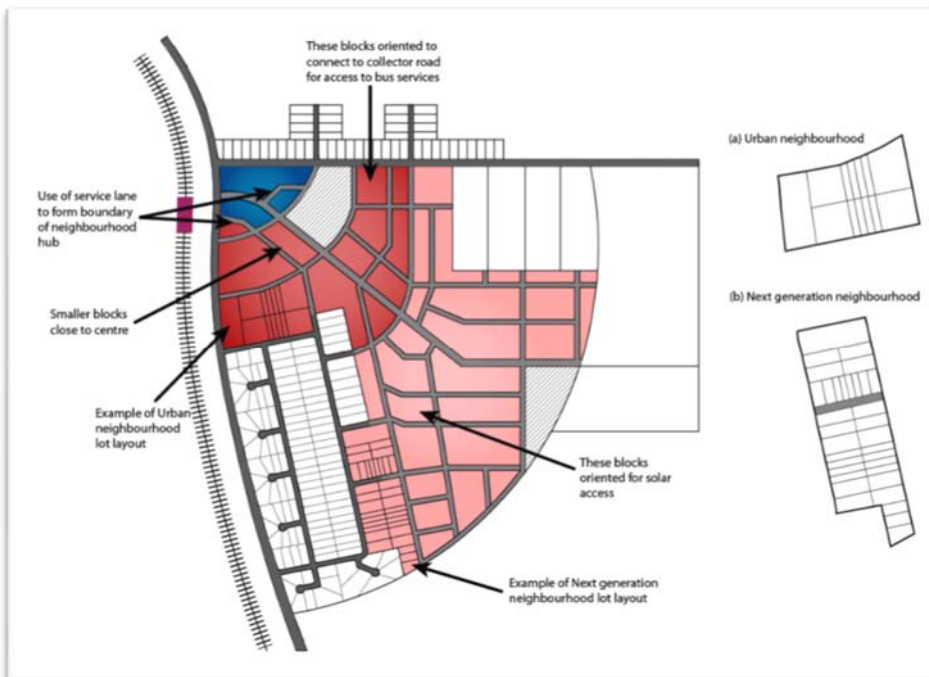

Layout refinement - development form

3 Neighbourhood development plans

3.1 Introduction

The Caboolture West Structure Plan was prepared by Moreton Bay Regional Council in consultation with State Agencies following the Ministerial declaration of the Caboolture West Master Planned Area in February 2012. The Caboolture West Structure Plan has been included within Council's new planning scheme as a local plan.

The Caboolture West local plan consists of 5 precincts and 15 sub-precincts. The location of the 5 precincts has been established as part of a comprehensive planning process (Shown on map LPM-03 contained in Schedule 2 of the MBRC planning scheme). The location of the 15 sub-precincts is required to be planned in more detail through the use of Neighbourhood development plans (NDP).

A NDP is the level of planning between the Caboolture West local plan and a development application. A NDP will show how the various sub-precincts, and places within the sub-precincts, are designed to form part of an overall integrated urban structure within the local plan area.

A series of figures are included within the Caboolture West local plan, which illustrate conceptually how Council intends the area will be developed. Neighbourhood development plans are intended to reflect these figures to show in detail the types, scale, timing and location of development and infrastructure prior to development occurring.

3.2 NDP areas

The Caboolture West local plan area is split into 8 smaller areas, for which a Neighbourhood development plan is required. The preparation of each NDP is a serious planning and design exercise. The completion of all 8 NDP's is expected to take place over a long period of time as development progresses through the local plan area.

The Figure below shows the 8 NDP areas along with colours indicating a conceptual sequence of expected plan preparation (dark to light), starting with NDP area 1 in the south east corner of the local plan area.

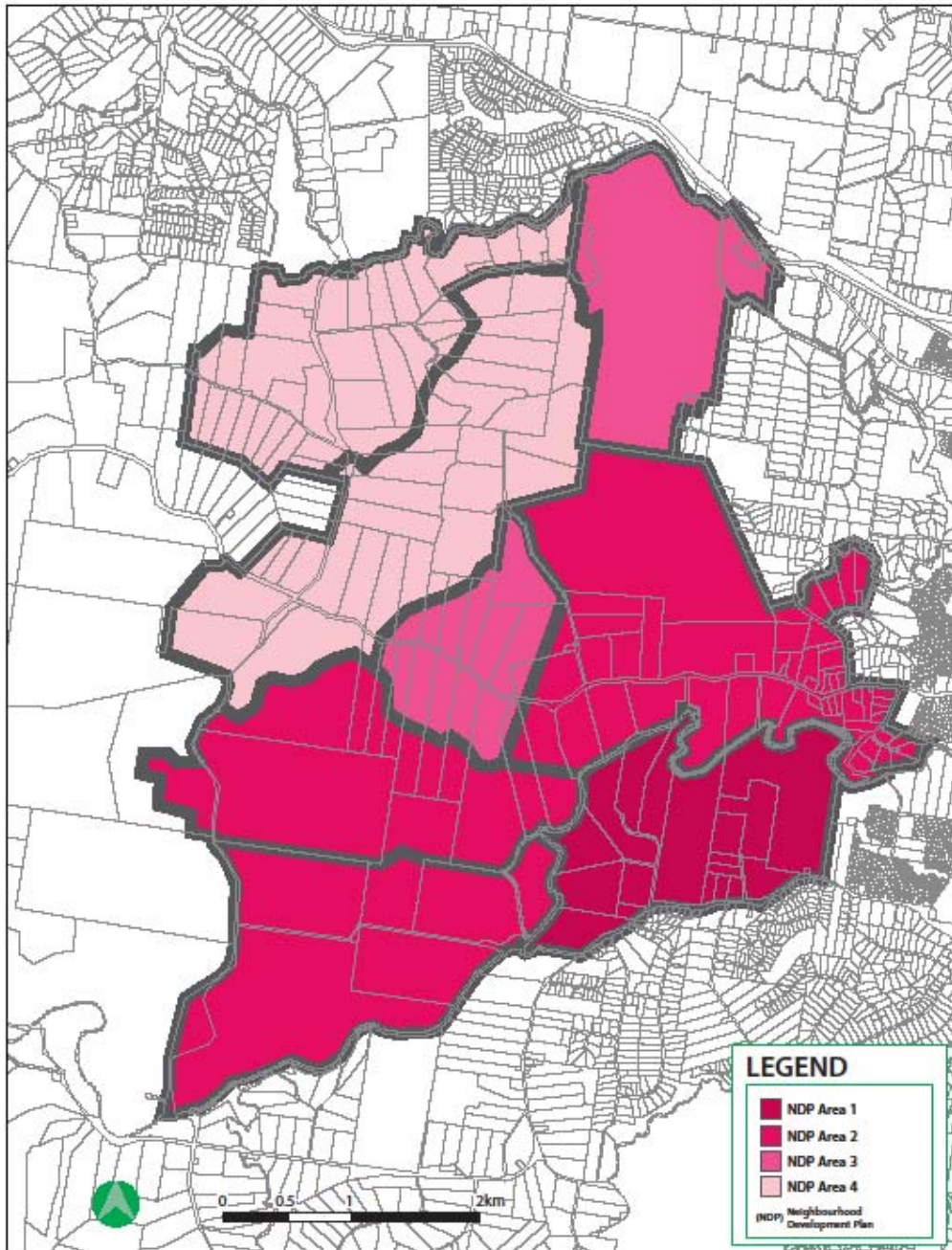

Figure 47: Caboolture West Neighbourhood development plan areas

3.3 NDP preparation process

It is Council's policy to require the preparation of a Neighbourhood development plan, in respect of development of land for urban purposes, prior to the issue of a development permit for a material change of use, reconfiguring a lot and operational work in accordance with the requirements of this policy.

The following steps outline the general process required to prepare a NDP. References are made to 'Neighbourhood Design' guidance material contained within the earlier sections of this planning scheme policy.

Step 1: Site context and environmental assessment

- 1.1 Establish the site context, major site features (e.g. land form, views, utility corridors, existing roads) and environmental constraints and opportunities (e.g. green network corridors, steep slopes, flood hazard, bushfire hazard, heritage and environmental values);
- 1.2 Produce a synthesised conditions analysis and establish the urban and non-urban areas for the NDP.

(Refer to Section 2 – Site Analysis and Conceptual Design for further information)

Step 2: External influences

- 2.1 Establish significant external connections to and from the site, such as existing roads, waterways, environmental corridors, view scapes and water catchments;
- 2.2 Identify external drainage and open space networks, existing and proposed facilities and services (e.g. schools and community facilities, services and centres) and employment opportunities and their relationship to the site;
- 2.3 Identify broad opportunities for integrated catchment management, the provision and multi-use of open space and non-residential facilities;
- 2.4 Produce a NDP context analysis that shows the main external influences and relationships with the NDP area that need to be factored into the NDP.

(Refer to Section 2 – Site Analysis and Conceptual Design for further information)

Step 3: Neighbourhood development, identity and integration

- 3.1 Identify the urban design typologies and relevant place types applicable to the NDP area;
- 3.2 Determine the location and nature of proposed and existing features and facilities, which will create focus and identity and achieve relatively self-contained, distinctive neighbourhoods with a strong 'sense of place';
- 3.3 Consider alternative development and density scenarios, which in turn, will influence the type, range and location of facilities and services to be provided (e.g. schools and centres);
- 3.4 Ensure that some flexibility is built into the various design options;
- 3.5 Define the preferred form of edge development to provide identity but also encourage integration with existing or future neighbourhoods.

(Refer to Section 2.2 – Outline plan for further information)

Step 4: Movement and service connections

- 4.1 Identify the movement and service corridor policies and principles to be addressed in the NDP process;
- 4.2 Establish major local movement systems into and out of the NDP area;
- 4.3 Identify opportunities for bicycle and pedestrian movements through and beyond NDP area;
- 4.4 Establish street connections to facilitate local and external movement and identify options for service connections;

- 4.5 Establish the basic movement network, linking existing streets where necessary and ensuring good local connectivity, permeability and legibility;
- 4.6 Ensure that motor vehicle networks do not dominate pedestrian and bicycle movements.

(Refer to Section 2.2 – Outline plan for further information)

Step 5: Integrated and coordinated urban design processes and techniques

- 5.1 Use urban design workshop/urban design processes to bring together the outcomes of steps 1 to 4 to develop/refine land use strategies for the neighbourhood (Refer to Section 2.3 - Refining the Layout for further information);
- 5.2 Produce land use options at scales between 1:5,000 and 1: 1,000 as required to map out in detail the NDP;
- 5.3 Refine the design outcomes to a level that enables the NDP to be used as an “acceptable outcome”;
- 5.4 Check for vertical integration between elements in the NDP;
- 5.5 Check for horizontal integration between elements in the NDP;
- 5.6 Check for alignment with MBRC planning scheme outcomes;
- 5.7 Convert movement networks to a street and path layout, considering issues such as safety, legibility, environmental capacity, allotment layout and orientation, and climatic factors;
- 5.8 Convert precincts, sub-precincts and movement networks into detailed land use, and block layouts and land requirements for non-residential activities and facilities;
- 5.9 Determine benchmark development densities, broad distribution of lot sizes, housing types and intended built form outcomes.

Step 6: Infrastructure Provision

- 6.1 Determine the type, scale, location and timing of development;
- 6.2 Produce a staging plan;
- 6.3 Assess the availability and capacity of existing reticulated water and sewerage, electricity and telecommunications infrastructure;
- 6.4 Estimate the demand for infrastructure that will be generated and identify the most appropriate means for provision;
- 6.5 Estimate the degree of costs to be borne by the public and private sectors arising from development and where appropriate, establish agreements regarding infrastructure pricing policy and provision.

Step 7: Prepare and publish final NDP Documentation

3.4 Planning elements to consider when preparing a NDP

There are many planning elements to consider and address throughout all stages of the NDP preparation process. This information is detailed below, including associated tasks that may need to be undertaken such as identifying, describing and mapping the relevant element/s.

Further guidance can be taken from the neighbourhood design material contained within earlier sections of this planning scheme policy, as well as the planning scheme policy for integrated design, which outlines Council’s standards for the planning and design of streets, roads and public spaces.

1. Site context and environmental values

(Refer to Section 2 – Site Analysis and Conceptual Design for further information)

- i) The NDP identifies, describes and maps:

- a. the site context and major site features (e.g. views, landscape character assessment, remnant vegetation);
 - b. environmental constraints and opportunities (e.g. slopes, gullies, flood-prone land, bushfire hazard, areas of instability, and environmental values) (*Refer to Section 12.3- Green Infrastructure Network*);
 - c. the significant external connections to and from the NDP area, such as habitat corridors, view scapes and water catchments;
 - d. external drainage and open space networks, facilities and services (e.g. schools and community facilities, services and centres);
 - e. broad opportunities for integrated catchment management, the provision of multi-use open space and non-residential facilities;
 - f. existing and approved development;
 - g. target population;
 - h. housing needs;
 - i. employment and business needs;
 - j. community facilities and services needs.
- ii) The NDP identifies, describes and maps how the development will:
- a. respond to site characteristics, settings, landmarks and views;
 - b. retain significant vegetation and habitat areas;
 - c. retain major natural drainage paths (rivers, creeks and watercourses) in their natural condition;
 - d. allow adequate buffers to development adjacent to major natural drainage paths;
 - e. implement TWCMP;
 - f. incorporate water sensitive urban design;
 - g. integrate the green network into urban design outcomes;
 - h. identify environmental offsets send and receive sites;
 - i. protect, frame and incorporate strong views.

2. Protection of agricultural land

- i) Where the NDP area involves productive agricultural activities, the NDP will:
- a. maintain existing lawful uses;
 - b. avoid detrimental impacts on amenity of agricultural activities;
 - c. avoid prejudicing the undertaking of agricultural activities;
 - d. not disadvantage opportunities for future urban development of land used for agricultural purposes.

3. Proposed land use

<i>(Refer to Section 2.2 – Outline plan for further information)</i>
--

- i) The NDP maps and describes the proposed land use structure including:
- a. a land use budget that identifies a balanced provision of all necessary space requirements (existing and proposed) for each of the uses and activities that may be provided as determined in response to the assessment of local area conditions including:
 - activity centres;
 - employment areas;
 - community infrastructure;
 - residential development areas;
 - streets;
 - environmental areas; and
 - water cycle management proposed.

- b. the predominate type, scale/density and location of development within each sub-precinct and the compatible/complementary mix of other land uses/services typically co-located with the predominant land use;
- c. the land uses/services that are incompatible with the predominant land use in each sub-precinct;
- d. the provision of centres, retail and commercial uses, community services and education facilities at focal points within convenient walking distance for residents;
- e. a mix of lot sizes that enables a variety of housing types and densities;
- f. higher densities in areas close to services, public transport and public open space, or areas with high levels of amenity;
- g. provide ancillary land uses;
- h. minimising the exposure of residential development to risks and hazards arising from the impacts of incompatible uses and natural hazards in the area, including segregation of land uses, provision of buffers, residents' exposure to electro-magnetic fields (from powerlines), exposure to noise from major roads, fire breaks etc.
- i. integration with the surrounding area, including development of the connected street systems and active transport.

4. Neighbourhood design and built form

(Refer to Section 2.2 – Outline plan for further information)

- i) Neighbourhoods are:
 - a. scaled for an easy 'five minute walk' (400m) from the edge to the centre;
 - b. 'Next generation' suburbs featuring diverse housing choice with a net density of at least 22 dwellings per hectare (Refer to Section 4 – Density, for further information);
 - c. clustered into groups of three or four within 800m of a local centre with boundaries which are clearly defined by major features like the river, creeks, or major gullies;
 - d. designed as distinctive places, providing attractive and safe living environments by incorporating a mix of compatible facilities and services, jobs, schools, recreation.
- ii) Neighbourhood design includes:
 - a. a range of block shapes and variety to facilitate an efficient neighbourhood pattern and scale;
 - b. connected streets and laneways;
 - c. pedestrian and cycle way connectivity;
 - d. the range of land uses identified as needed in the NDP area;
 - e. housing choice within a neighbourhood and within a block;
 - f. transition of building heights at the street and block;
 - g. a table that specifies the broad distribution of lot sizes, lot mix and housing types to achieve housing diversity;
 - h. minimum site densities;
 - i. street set back requirements
 - j. sub-tropical design principles.

5. Street networks

(Refer to Section 2.2 – Outline plan for further information)

- i) The NDP maps and describes:
 - a. the existing transport network of the area;
 - b. a permeable, legible, street and pedestrian/cyclist network providing connectivity, and property access, walkable neighbourhoods, active transport and public transport services;
 - c. a safe and convenient movement network within the local plan area and to and from the surrounding areas;

- d. a safe and attractive pedestrian friendly built environment.
- ii) The NDP includes a street network that has:
 - a. an 800m grid of major streets, modified by topography, which provides a higher order street network with district and regional connectivity;
 - b. a 400m grid of local collector streets;
 - c. a fine-grained connected street network within the grid to increase travel choices, and to distribute and lower traffic on major streets so that all streets can support land use functions (e.g. housing) and qualities other than solely transport;
 - d. a hierarchy of 4-lane streets and 2-lane streets and laneways;
 - e. limited access roads (Refer Section 10 - Limited Access Streets);
 - f. local streets designed to be suitable for bus routes;
 - g. local connections to surrounding neighbourhoods.
 - iii) The NDP includes a PT network that:
 - a. connects the NDP area to adjoining areas;
 - b. provides a network of local routes within 400m safe walking distance from existing or potential dwellings that connects to local centres and community facilities;
 - c. utilises local streets designed suitable for bus routes.
 - iv) The NDP includes an active transport network that:
 - d. includes a 200m grid of local access streets, on street pathways and off street pathways;
 - e. provides a safe, convenient and legible network for pedestrians and cyclists;
 - f. includes on-street cycle paths plus off-street walking and cycling paths on all major streets;
 - g. includes an off-street path network taking advantage of the green network;
 - h. connects destinations people want to go to around the town;
 - i. is supported and well-connected by an 800m grid of streets.

6. Public open space and community facilities

(Refer to Section 2.2 – <i>Outline plan</i> for further information)
--

- i) The NDP maps and describes:
 - a. the existing public open space and community facilities within and adjacent to the NDP area;
 - b. the forecast needs for public open space and community facilities in the NDP area;
 - c. locational and design criteria for public open space and schools;
 - d. the proposed community infrastructure needed in the area having regard to (a) and (b) above;
 - e. the proposals contained in preceding Council master planning, structure planning relevant to the NDP area;
 - f. a land use budget that identifies balanced provision of all necessary public open space and community facility space requirements (existing and proposed) including:
 - i. primary and high schools;
 - ii. regional and district sports;
 - iii. district and local recreation park requirements; and
 - iv. allowance for protection of and integration with environmental areas, and water cycle management requirements.
- ii) Park and open space planning and design:
 - a. takes into account existing and forecast needs for park and open space in accordance with Council's strategic infrastructure planning requirements for the area;
 - b. includes the size, type, distribution/location and site boundaries of all proposed parks and open space;

- c. provides a legible network of public open spaces, links and pathways and preserves the river and creek waterway and flood plains (land below the ultimate Q100 floodline);
- d. complements planning and design for the protection of the natural environment and landscape character by providing “stepping stones” for wildlife movement; retaining natural vegetation without compromising the role and function of the park to meet user needs;
- e. is used to define the boundaries of the neighbourhoods and provide community focal points.

iii) Schools planning and design:

- a. takes into account existing and forecast needs for schools in accordance with State government schools planning guidelines and requirements;
- b. includes the size, type, distribution/location and site boundaries of all proposed schools;
- c. using the locational and design criteria for schools integrate schools into the design of the neighbourhoods including the park and open space, active transport, public transport and the street networks;
- d. complements planning and design for the protection of the natural environment and landscape character by providing “stepping stones” for wildlife movement; retaining natural vegetation without compromising the role and function of the school site to meet user needs;
- e. while non-government school locations are not identified they are assumed to adopt the same locational and design criteria as government schools.

7. Public utilities and other infrastructure

i) The NDP maps and describes the existing and proposed public utilities and other infrastructure required to support development of the NDP area including the type, scale, location and timing of:

- a. water supply;
- b. wastewater transport and treatment;
- c. power supply (electricity and gas);
- d. communication services;
- e. stormwater management system;
- f. existing natural wetlands;
- g. large dry detention basins of an appropriate size and shape to be adapted to passive recreation.

ii) Public utility and other infrastructure is:

- a. located and designed to maximise efficiency, ease of maintenance, and minimum whole of life cycle cost;
- b. provided in a timely, orderly, coordinated and integrated manner to support urban uses and works;
- c. delivered in a manner that does not compromise the planned networks and hierarchies;
- d. co-located where reasonably practical;
- e. located and designed to minimise impacts on natural environmental values and integrated into the design of distinctive, safe and attractive urban places;
- f. designed to create high quality living and working environments that are safe, convenient, attractive, comfortable and fit for purpose.

8. Land ownership, development coordination and consultation

i) Where the NDP involves multiple land owners the NDP will:

- a. maintain existing lawful or mutually agreed access to third party lots;
- b. avoid detrimental impacts on amenity of third party lots;
- c. avoid prejudicing the development of third party lots by unreasonably shifting the costs of infrastructure;
- d. guide and coordinate the staged development of the NDP area and the provision of necessary infrastructure;
- e. include methods for continuing community involvement in plan preparation;
- f. remain current for development applications until Council endorses a new NDP.



PART 2

RESIDENTIAL AREAS

4 Density

4.1 Definition

There are three measures of density used in the planning scheme:

- Land use intensity
- Dwellings per hectare (d/ha)
- Lots per hectare (lots/ha)

Land Use intensity

This measure is used in the Strategic Framework, which seeks a minimum of 35 residents or jobs per hectare, regarded as the minimum density to support a reduction in vehicle dependency.

The aim of meeting this target is translated into the scheme in the way that it identifies land uses, density, building and lot forms.

Some areas, such as the urban precinct, have higher minimum densities. This supports the aims of Council to raise the intensity of use in these areas above the minimum level. Other areas (e.g. suburban neighbourhoods) have a maximum density either because they are not centrally located or they have an established low intensity which is not intended to be changed in the life of the planning scheme.

Dwellings or Lots Per Hectare

These measures are used in the general residential zone and reconfiguring of a lot (RAL) codes. Both measure the number of houses per hectare of land. The minimum density specified in the next generation RAL code—15 d/ha—is consistent with the 35 people per hectare specified in the strategic framework.

- **Net Residential density** is used for reconfiguring a lot and measures *lots per hectare*.
- **Site density** is used in the zone code and measures *dwellings per hectare*. It is generally used for individual sites after reconfiguration.

The creation of new lots requires the creation of new roads and infrastructure. Typically, this takes up a third of the pre-development site.

This infrastructure does not need to be provided at the dwelling stage. For this reason, a site density (dwellings per hectare for the development site only) will be higher than net residential density.



Development Site: 10.5ha of developable area

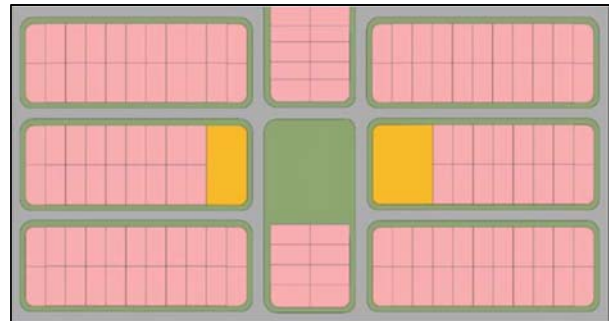

Lot Layout: 142 lots (including 2 large lots for dwelling units). Net Residential Density is 13.5 lots per hectare (142 lots/10.5ha total area)

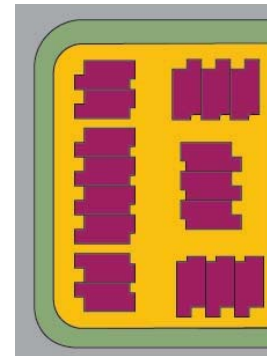

Site Density is 63 dwellings per hectare on this multiple dwelling site (17 dwellings / 0.27ha site area)

Site Density and Net Residential Density

4.2 Measuring Density

All residential density measures are calculated using the same basic ratio formula: the number of dwellings divided by the area of land they occupy.

$$\text{Residential Density} = \frac{\text{Number of lots or dwellings}}{\text{Land Area}}$$

Site Density

A site density is calculated from the site area and the number of dwellings. Some examples are:

- 1 dwelling on 500m² = a site density of 20d/ha.
- 2 dwellings on 500m² = a site density of 40d/ha.
- 10 dwellings on 1500m² = a site density of 66.6d/ha.

A calculation for site area is as follows:

$$\text{Site Density} = \frac{\text{Number of lots or dwellings}}{\text{Land Area}}$$

Net Residential Density

Net residential density is the number of lots or dwellings divided by the total area for the development - known as the developable area. This area includes certain items of infrastructure (such as local roads) but excludes others. The box on the right shows what is included in developable area.

The calculation for Net Residential Density is:

$$\text{Net Residential Density} = \frac{\text{Number of lots or dwellings}}{\text{Land Area}}$$

Developable Area

Land Included in Calculation

- All land for residential purposes
- Land for mixed use containing residential uses
- Land for local parks
- Land for local roads (including half of road boarding the site)

Land Excluded from Calculation

- Land for purposes other than residential
- Parks servicing the broader region (e.g. district parks)
- Sports fields
- Higher order roads (arterials, sub arterials or district collectors)
- Land deemed to be undevelopable due to constraints such as flooding, future roads requirements, steep land and significant vegetation.



Net Residential Density Inclusions

4.3 Converting between Site Density and Net Residential Density

A net residential density includes the land required for roads and local parks. As a result it will always be lower than site density. A typical outcome is that around a third of the land will be used for roads and parks.

A site development is not always associated with a reconfiguration application, but it is useful to be able to compare the densities in a single measure.

As a result, the MBRC planning scheme includes an assumption. To convert between site density and net residential density, the amount of land used is inflated by 1.5 as shown below.

- 5 dwellings on a combined site area of 1000m² = 50d/ha site density.
- To convert this to net residential density we multiply the land area by 1.5: the same 5 dwellings on (1000m² * 1.5 [1500m²]) = 33.3d/ha net residential density.

This conversion should not be used for larger sites required to provide their own internal public roads or public open space i.e. greenfield RAL development. Site density applies to Material Change of Use development.



Development Site: 10.5ha of developable area

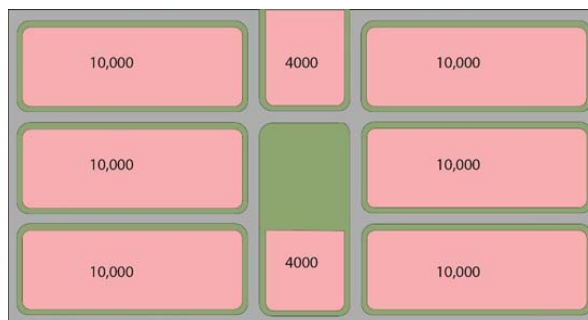

Site Area: 6.8ha of land is available for sites

Developable Area: In the example above 6.8ha is available for lots out of a total developable area of 10.5ha. 6.8ha * 1.5 gives a calculated developable area of 10.2ha.

Density in the MBRC Planning Scheme	Residential place types / General residential zone precincts			
	Coastal Communities Place type/ precinct	Suburban Place type/ precinct	Next generation Place type/ precinct	Urban Place type/ precinct
Strategic Framework	N/A	Max 11 dwellings/ha - Net residential density	Min 15 dwellings per ha	60 people and/or jobs per ha ⁽²⁾
Reconfiguring a lot code (Net Residential Density)	Max 11 lots/ha	Max 11 lots/ha	11-25 lots/ha	N/A ⁽³⁾
General residential zone code (Site Density)	Max 15 dwellings/ha	Max 15 dwellings/ha	15-75 dwellings/ha - Site density	Min 45 dwellings/ha or Min 75 dwelling/ha

1 - equates to 15 dwellings / ha

2 - equates to 30 dwellings / ha

3 - must not compromise the precincts future ability to achieve a minimum site density of 45 dwellings

5 Housing Diversity

The Moreton Bay Regional Council Planning Scheme aims for a variety of dwelling types to be built in the region, especially in Next Generation Areas.

Dwelling diversity provides a mix of dwellings that meet the different needs of a wide range of people in society.

Housing diversity enables neighbourhoods to provide for changing demographics, helps address housing affordability issues and provides for different lifestyle choices and life stages.

A diversity of housing can contribute to the visual interest of the streetscape.

MBRC have developed 5 principles for delivering successful housing diversity.

Principles for successful housing diversity	
Affordability	Affordability is a key principle of housing diversity. The house types need to take into consideration all aspects relating to cost, not just the cost of construction. These costs include proximity to employment, schools, public transport and services and the use of materials, equipment and technology that reduce the running cost of a home. For the subdivision of land, developers should consider issues such as orientation, lot design and distribution and location of densities to promote environmental sustainability.
Amenity	Amenity for the occupants of new dwellings and for surrounding neighbours is a significant issue that must be addressed when designing for housing diversity, particularly in established areas. Building designs that consider the streetscape, prevailing breezes and access to winter sun, both on-site and on neighbouring premises, will ensure that the amenity for occupants and their neighbours is maintained. At the subdivision stage, consideration of these issues is important especially with regards to the design and placement of smaller allotments and the use of retaining features within lot boundaries.
Privacy	Privacy for the occupants of new dwellings and for surrounding neighbours is regularly raised as a major concern where smaller allotments and units are proposed. Appropriately designed dwellings will ensure that privacy, both visual and acoustic, is maintained, whilst not impeding active streetscape outcomes and neighbourhood interaction.
Wide Choice	The housing market for smaller homes is not limited to one particular house type or lot size. A wide range of housing product needs to be delivered to ensure that there is adequate choice for homebuyers at varying stages of life and in varying financial position, and to ensure diversity within the overall streetscape.
Salt and peppering	It is important that diverse housing forms are not clustered in only one location in a neighbourhood, but that they are dispersed in a variety of locations. There may still be localised 'clustering' of housing types, however, it should not be to an extent which clearly identifies an area as being different to otherwise similar areas. The secret to successful housing diversity is to normalise it.

5.1 Lot Types and Lot Mix

The mechanism used in the planning scheme to provide for housing choice is a diversity of lot widths. Lot depths are expected to be constant (between 25m and 35m) with a variation in size created by varying the width along the street. Wider lots (above 32m) are provided for multiple dwelling typologies.

Different lot mixes are required depending on the precinct in the planning scheme.

The following diagrams illustrate how the lot mix can be achieved. These are for conceptual purposes only and should not be relied upon for justification against the Performance Outcomes of the code.

Suburban Neighbourhood Precinct

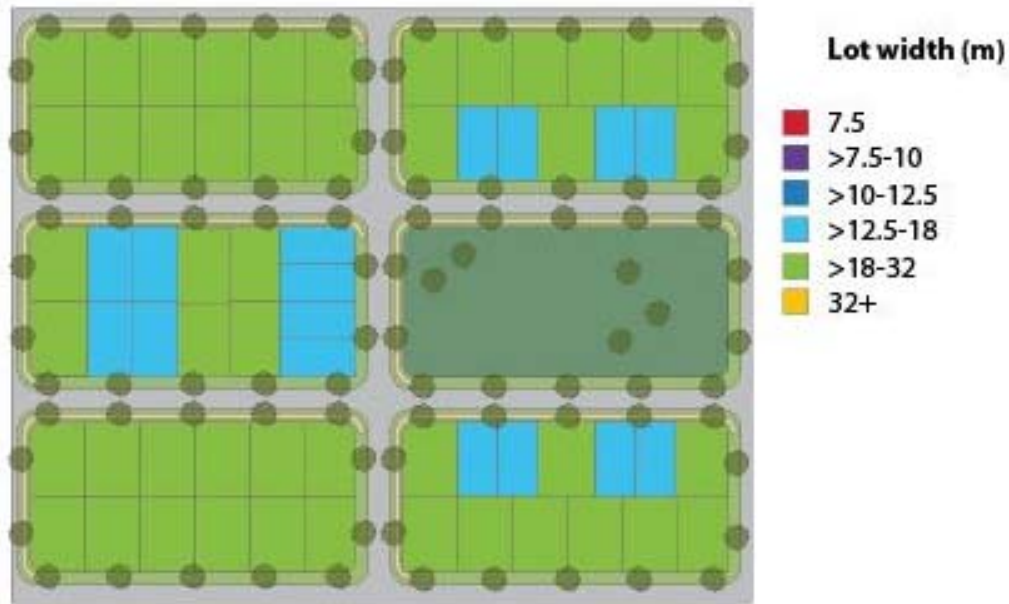

Conceptual Suburban Neighbourhood

<i>Total Site Area</i>	3.9 Ha
<i>Total Lots</i>	64
<i>Average Lots / Block</i>	12.8
<i>Site Density</i>	16 lots / Ha
<i>Average Lot Size</i>	609m ²
<i>Net Density</i>	10.6 lots / Ha
Breakdown of lot types	
<i>Lot Type (frontage width)</i>	<i>No. of Lots</i>
D >12.5 - 18m	16
E >18 - 32m	48

Next Generation Neighbourhood Precinct

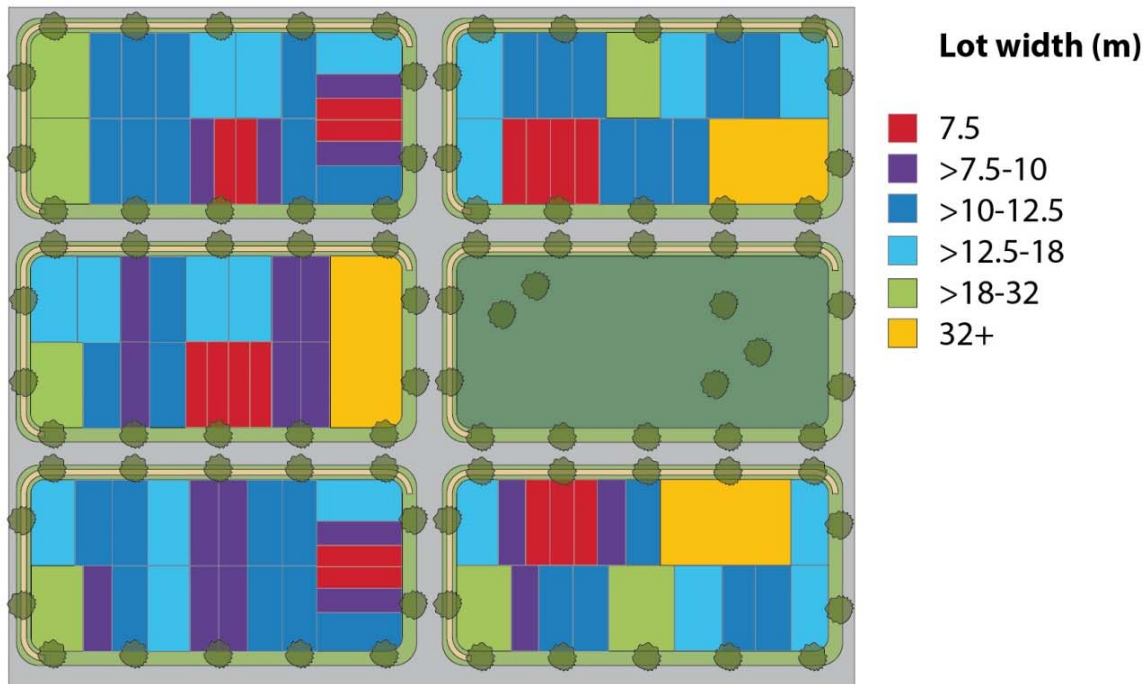

Conceptual Next Generation Neighbourhood

<i>Total Site Area</i>	3.9 Ha	
<i>Total Lots</i>	99	
<i>Average Lots / Block</i>	19.8	
<i>Site Density</i>	25.4 lots / Ha	
<i>Average Lot Size</i>	393m ²	
<i>Net Residential Density</i>	16.5 lots / Ha	
<i>Breakdown of lot types</i>		
<i>Lot Type (frontage width)</i>	<i>No. of Lots</i>	<i>% of total lots</i>
A 7.5m	17	17.2 %
B >7.5 - 10m	20	20.2 %
C >10 - 12.5m	33	33.3 %
D >12.5 - 18m	19	19.2 %
E >18 - 32m	7	7.1 %
F >32m	3	3.0 %
<i>Following Comprehensive Redevelopment of 30m+ frontage lots</i>		
<i>Total dwellings</i>	111	
<i>Average dwellings / block</i>	22.2	
<i>Site Density</i>	28 dw / Ha	
<i>Net Density</i>	18.4 dw / Ha	



Mixed Density Next Generation Neighbourhood designed around a central park

Urban Neighbourhood Precinct

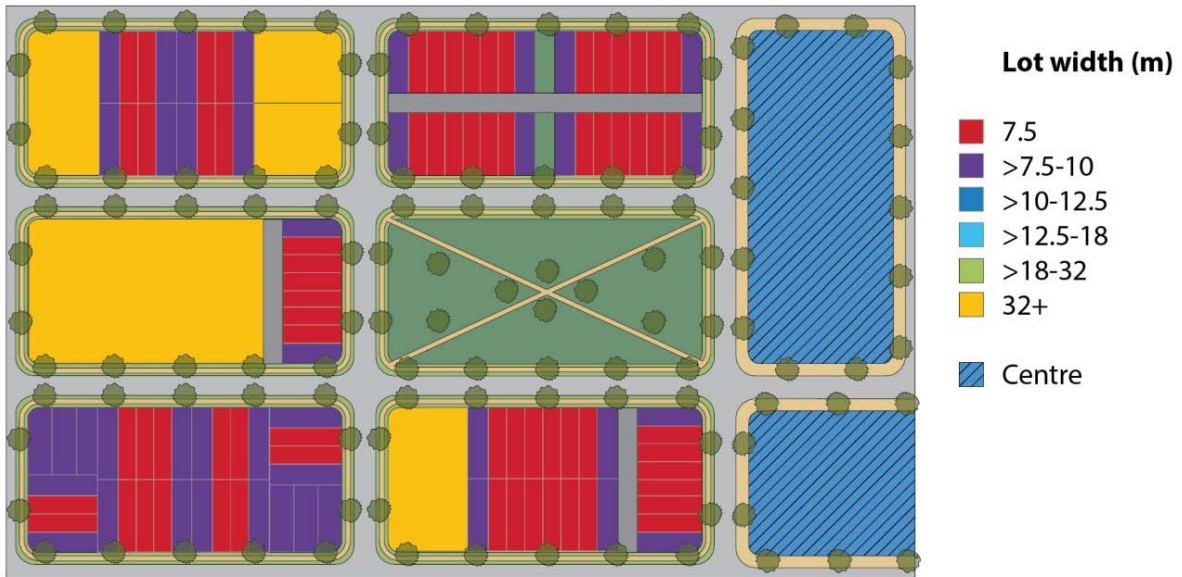

Conceptual Urban Neighbourhood

Total Site Area	3.9 Ha	
Total Lots	117	
Average Lots / Block	23.4	
Site Density	30 lots / Ha	
Average Lot Size	333m ²	
Net Residential Density	19.8 lots / Ha	
<i>Breakdown of lot types</i>		
Lot Type (frontage width)	No. of Lots	% of total lots
A 7.5 m	70	59 %
B >7.5 - 10 m	42	35 %
F >32 m	5	4.2 %
<i>Following Comprehensive Redevelopment of 30m+ frontage lots</i>		
Total dwellings	175	
Average dwellings / block	33	
Site Density	45 dw / Ha	
Net Density	30 dw / Ha	

6 Street Design and Layout

6.1 Grid Structures

Cities were traditionally built on a grid structure with a walkable perimeter of around 400m-800m. For instance, much of Brisbane has a grid with dimensions of 100m x 200m. This structure ensures that it is possible to walk anywhere within the area relatively easily.

More recently, with the widespread use of cul-de-sacs and other forms of poorly connected road pattern, street layouts have become less well connected and urban areas less walkable.

9.

Rectilinear Grid

Traditional city structure is connected and supported change over time.

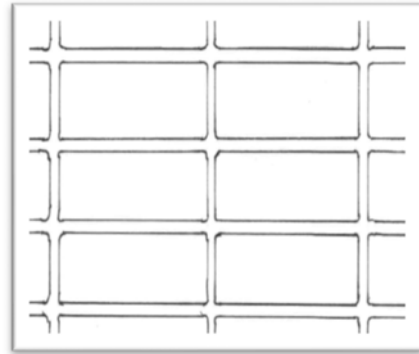

Modified Grid

A modified grid such as the one above can be used provided it has an overall structure that is legible. The example above has a choice of direct routes running north-south and east-west even though the orientation of grid cells is alternated.

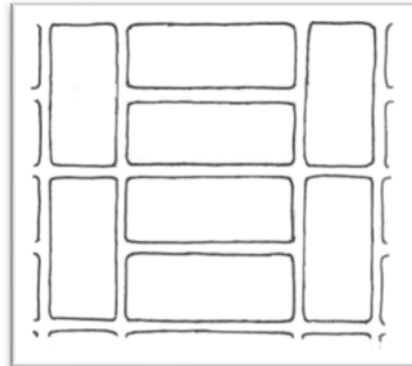

Radiant Grid

Radiant grids are a way to respond to a focal point such as a station or town centre as they minimise travel distances from a central point. Away from the focal point, the grid should transition to a rectilinear form.

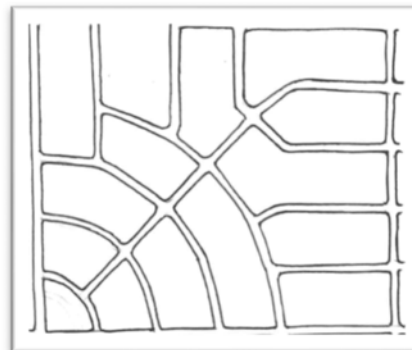

Non-preferred Road Patterns

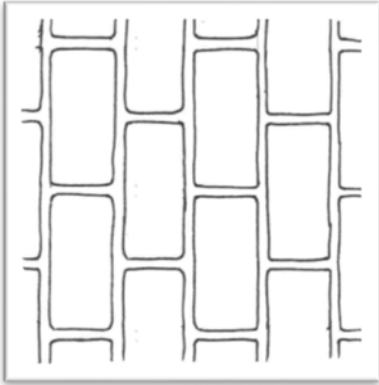

Offset Grid

An offset grid such as the one above does not provide for east-west connections.

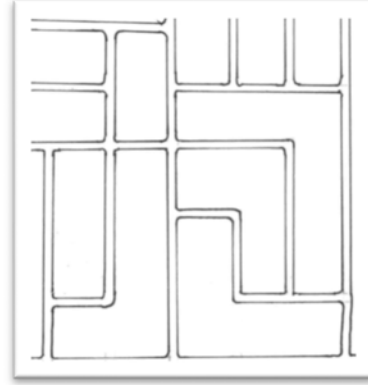

Fragmented Grid

A fragmented grid does not have the structure or legibility of a regular grid.

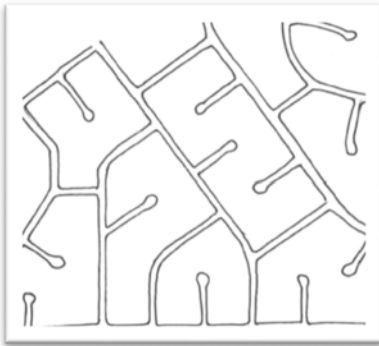

Loops and Lollipops

The occasional use of cul-de-sacs within a structured grid may be acceptable, but their widespread use must be avoided.

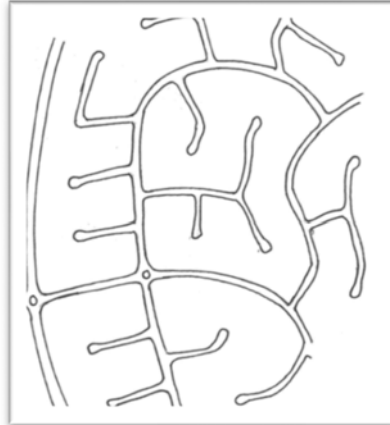

Dendritic

Highly disconnected car-dependent layouts are not acceptable.



Fake Grid

A fake grid has many of the attributes of a grid based layout but is not well connected. It does not provide direct routes for travel and is not legible.

6.2 Block Dimensions

Blocks will generally have a depth of between 50 and 70m. Block width will usually be around 2-3 times the depth of the block.

The maximum block dimension depends on the residential precinct in which the development is located, as shown below. Block lengths greater than 200m should be used sparingly and a mid-block pedestrian link provided.

General Residential Zone – Precinct	Maximum walkable perimeter
Coastal Communities & Suburban Neighbourhood	600 metres
Next Generation Neighbourhood	500 metres
Urban Neighbourhood	400 metres

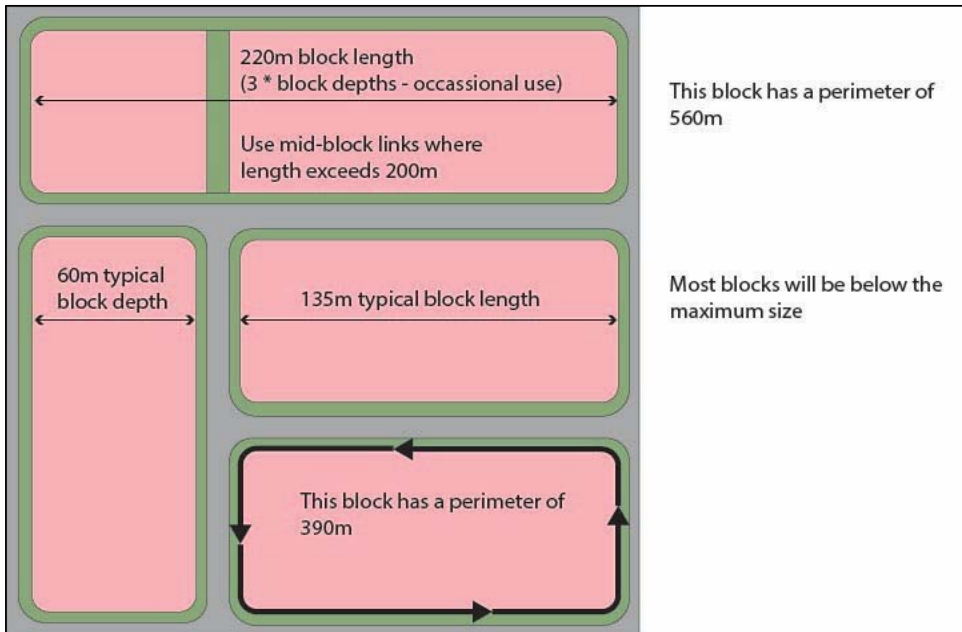

Walkable Perimeter



Mid-Block Connection (Caloundra West)

6.3 Connecting to the existing and future street network

Existing Street Network

Where there is an existing network around the site, such as for an infill subdivision, the points of connection (both streets and off-road connections) should be identified at the start of the design process.

All new subdivisions should ensure that multiple connections are provided to the external road network for emergency access. On larger subdivisions (> 300 lots), multiple access points will generally be required by the 300th lot. For smaller subdivisions (< 300 lots), multiple connections will be required sooner.

The importance of these connections should be evaluated before a decision is made how connections through the site should be made

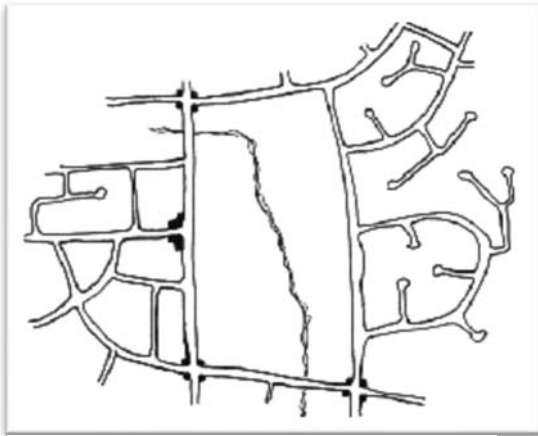

1. Development site and surrounds

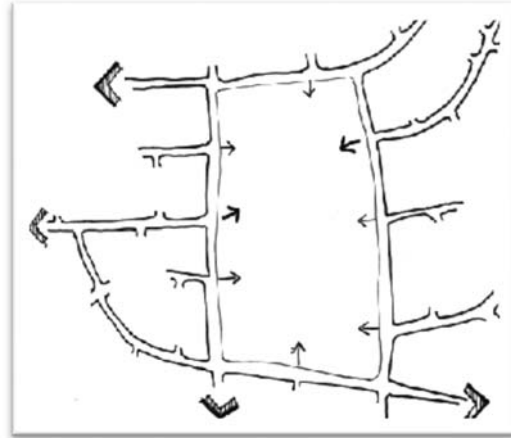

2. Identify points of connection and importance of these points



3. Identify possible road layout for the development



4. Refine layout

Neighbouring Sites

Where existing development backs onto the site, development new development should respond to the existing pattern by connecting up roads logically and ensuring that houses sit back to back.

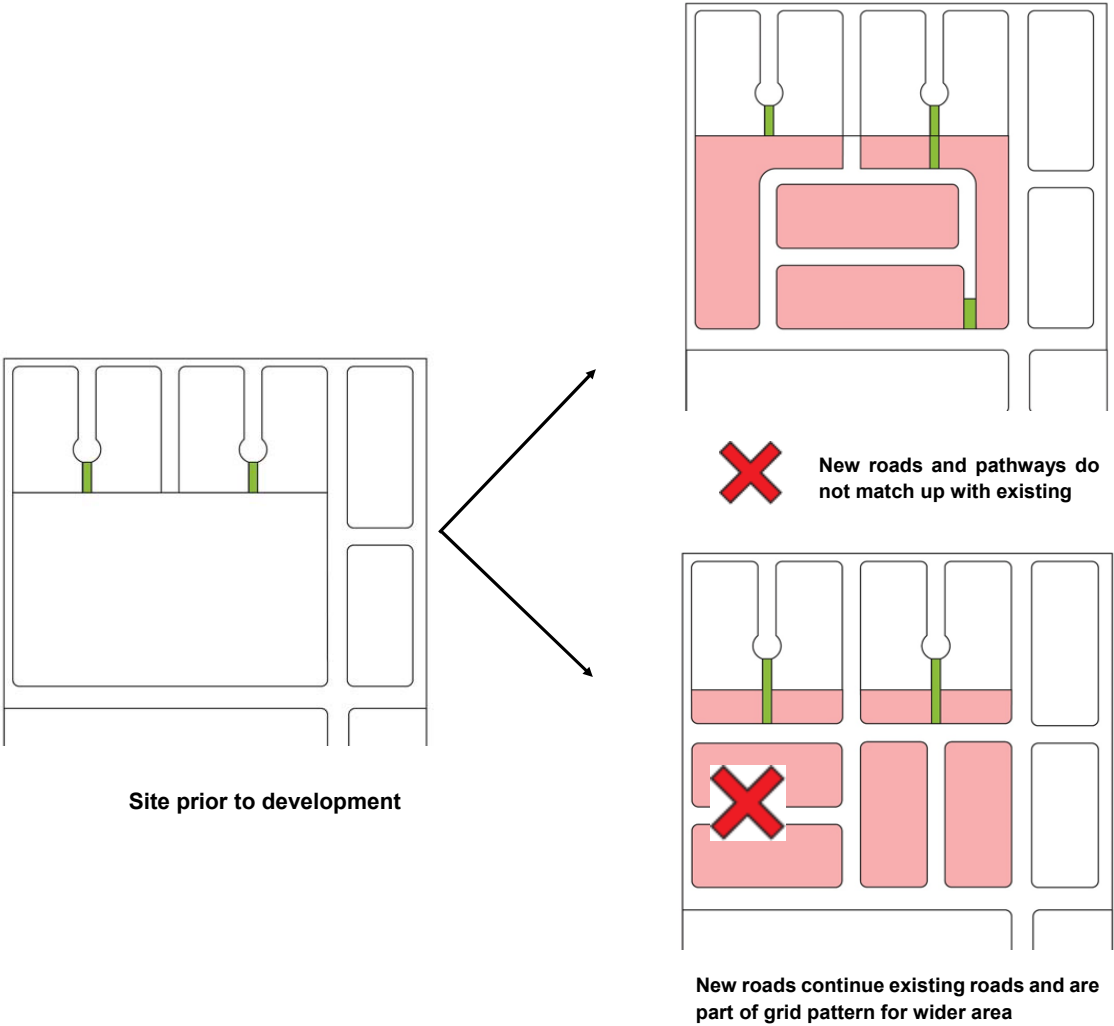

Providing for Future Connections

Where land adjacent to the site will be developed in future, access must be provided in a way that is consistent with a grid pattern, with a maximum block perimeter (as specified in the Reconfiguring a lot code). Future development can then be integrated into grid with appropriate block sizes.

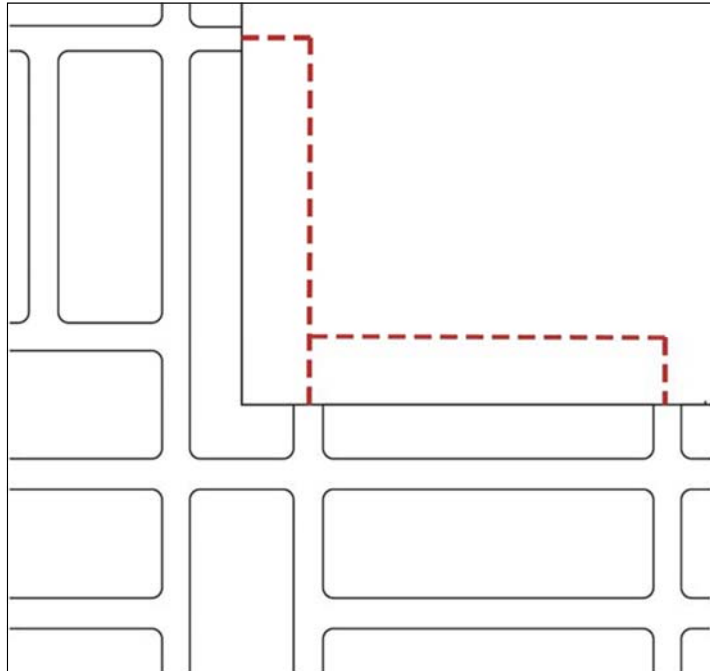

7 Integration Plans

Where reconfiguration of a lot or large multiple dwelling complexes are proposed, there is a need to ensure that connections are provided to complete a walkable grid.

Where this occurs, an integration plan is required. This is intended to demonstrate that neighbouring properties can be developed in a logical manner and that connection through the area are provided. The integration plan must be drawn over the wider developable (not just the site and neighbours).

Indications that connections are needed are:

- To complete the street grid at the perimeter block required for the precinct.
- Where length of street would exceed 200m.
- Where there is an existing road stub.
- Where there is a connection shown on a movement network diagram (located within the planning scheme).

Connections will usually be provided in the form of roads, unless there is a reason this is problematic. Where roads are not possible and with the agreement of Council, they may be provided as walking connections.

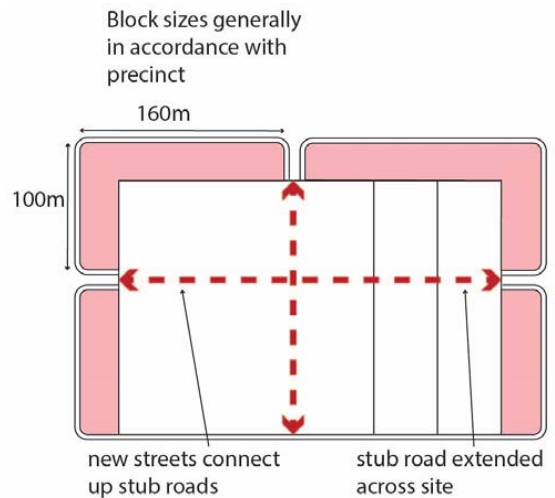

Integration of large site within neighbourhood

Area for Integration Plan:

The Integration plan must be drawn over the logical wider development area, not just surrounding sites. In this example, the boundaries are formed by existing development, flooding and an arterial road.

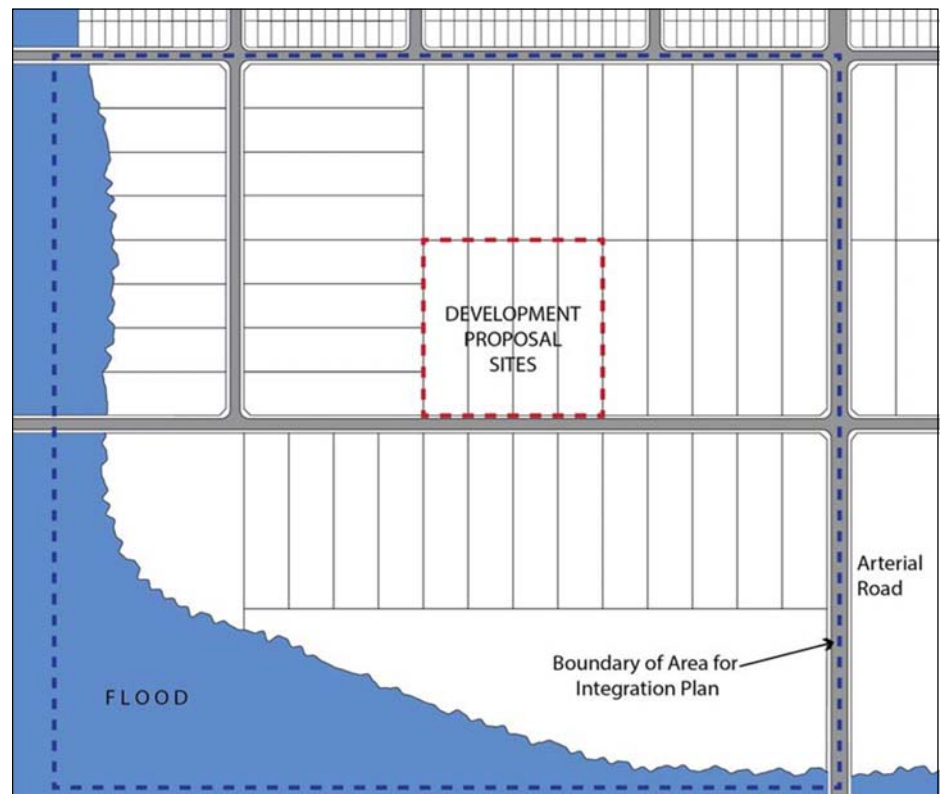



This development pattern does not provide connections from the existing stub roads and would result in a block perimeter of at least 1km.



This development pattern provides a block perimeter of 600m and uses the existing road stubs in a logical manner



Dwelling Complexes may require new road

Integration plans will need to demonstrate how units complexes comply with the connectivity standards for the precinct

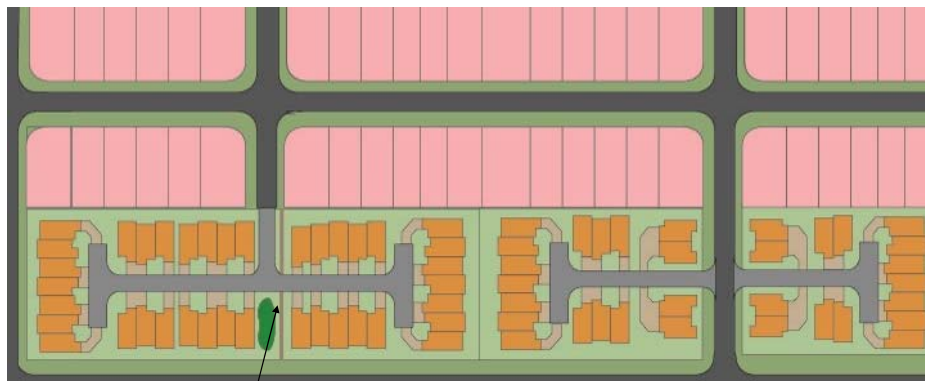

WALKWAY

Connections will usually be provided as roads.

In the example on the left, a walkway is provided as intersection spacing cannot easily be met.

8 Street Hierarchy

The diagram below is a model of a large suburb with a population of around 25,000 people. It illustrates the pattern of major roads and how they are integrated across developments.

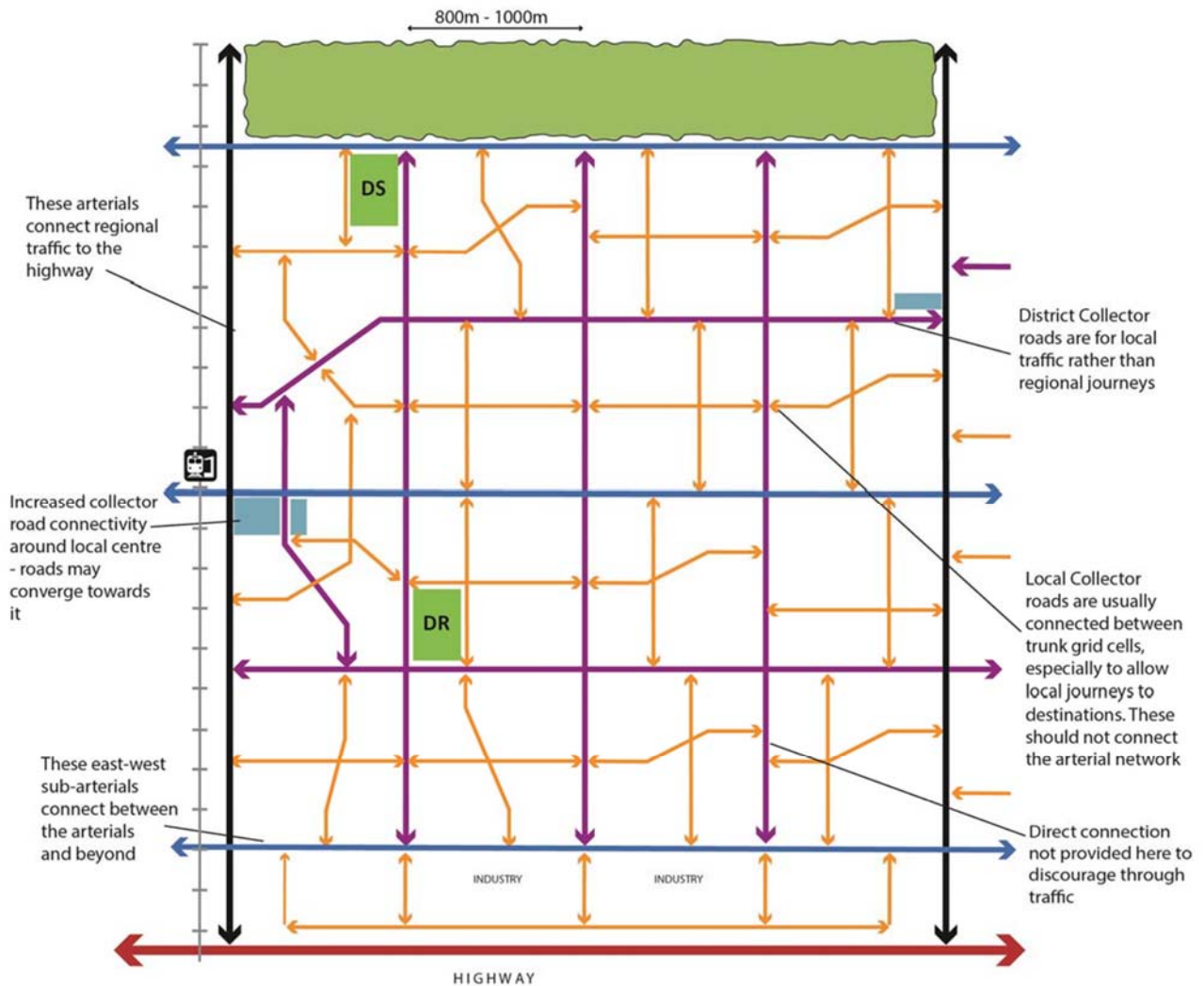

- Highway
- Arterial
- Sub-Arterial
- District Collector
- Local Collector
- Local Access
- - - Walkway / Cycleway
- Park
- Environmental Area
- Local Centre or Neighbourhood Hub

8.1 Street Hierarchy and Structure

Road Network Plans

Any development where public road will be built will require a Road Network Plan to be drawn. This is a diagram showing how the roads function and the role they perform in the road hierarchy.

Framework Roads

A neighbourhood is structured around a framework of higher order streets (e.g. local collectors) that act as the main transport corridors and provide for a variety of uses. The first stage of neighbourhood design is the location of these frame roads. The rest of the grid of local streets is then structured around them.

The location of major roads (sub arterial and district collector) will usually be determined by master-planning undertaken by or in conjunction with Council.

Local Streets

The local street network will be a mixture of directly connected streets for local traffic and short streets, most likely in a modified grid.

Streets should form a logical grid pattern with a dimension of not more than 200m to provide for direct journeys. This grid will be formed with a mixture of local collector roads and local access streets, as shown in the diagram.

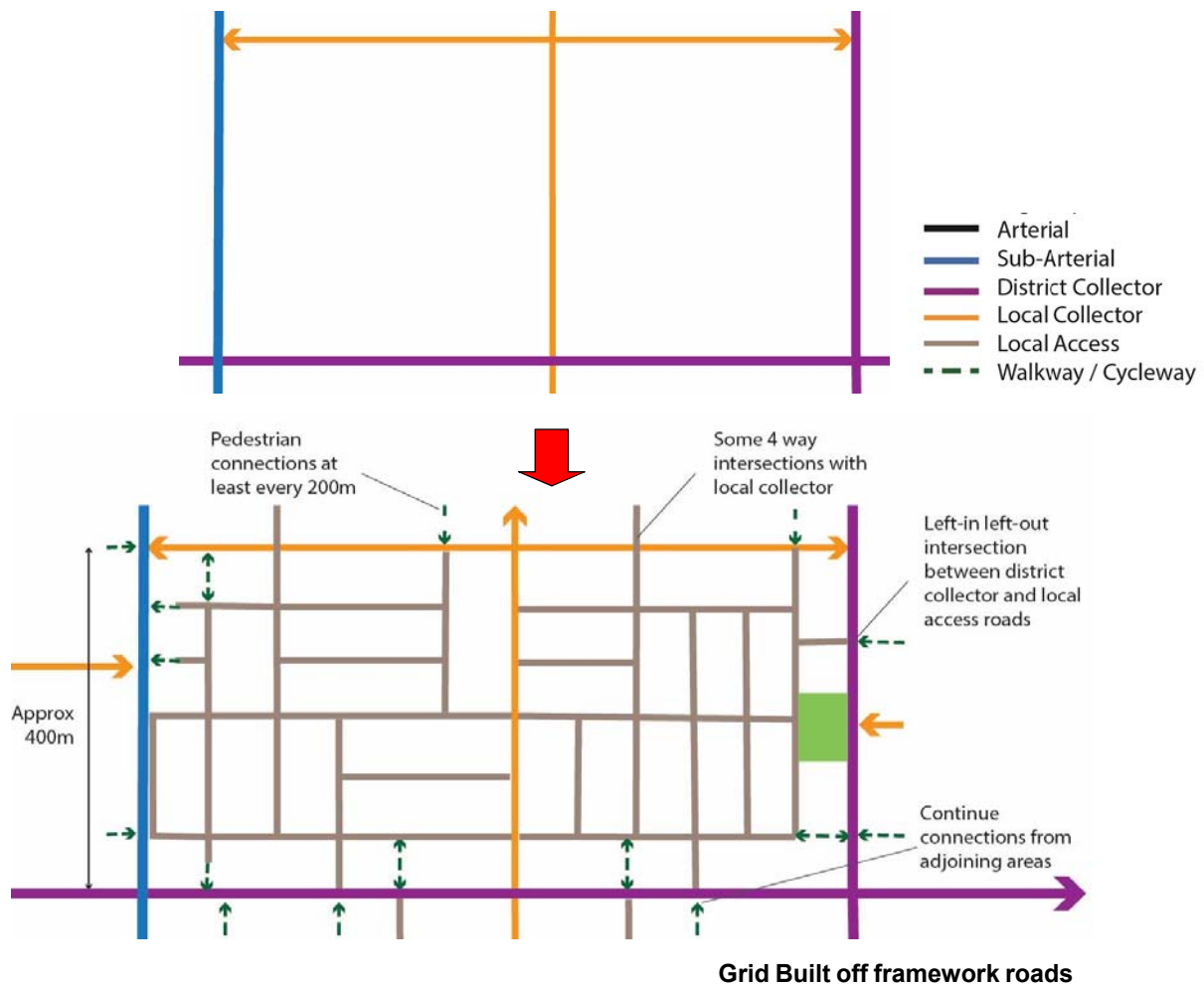

8.2 Local Street Types

Local Collector Roads

Local collector roads will connect between neighbourhoods but will not form a continuous connection between main destinations. They are not intended to provide an alternative route to district collectors. Rather, they distribute traffic within and between neighbourhoods.

The required frequency of local collector roads is a matter of circumstance. They will be needed to provide access between neighbourhoods and centres (and so more will be required around centres). In residential areas, they generally form a grid of 400m-500m dimension.

Local Access Streets

Local access streets are quiet local streets. They should be part of a connected street network and they may provide for some through movement, although the principle traffic distribution should be provided by the local collector.

They may be connected to a District Collector road (usually with a left in left out intersection) but they will not be connected to sub-arterial or arterial roads.

Collector Roads

The design of collector roads may be more complicated than other roads because of the need to take account of the different functions. A collector road is a multi-purpose street which must provide for place activities as well as movement activities. It needs to be a pleasant and attractive place for people, but still provide higher capacity for movement.

Place activities can include space for social activities such as seating areas and space for people to stop and linger; and amenity space such as landscaping and trees. Collector roads are also a good place for commercial activities.

It is important that these streets have a high level of amenity because they also function as liveable streets with direct residential frontage. They are also the best locations for parks and community facilities because of their higher profile.

There are two types of collector roads: Local and District. Local collector roads distribute traffic round a local neighbourhood while district collectors distribute it around a larger area such as a town or suburb. The role of these is shown in the diagram on the previous page.

Individual property access to District Collector roads is usually not permitted. Some alternatives are illustrated in section 9.

Local Collector Road with rear accessed row housing



8.3 Intersection Types and Spacing

A development layout is greatly influenced by the requirements for intersection spacing, especially where it is close to major roads. This can dictate the orientation of the grid and in some cases whether a connection is possible.

MBRC Planning Scheme intersection spacings are shown on the right and in the diagram below.

Road Type	Direct Access	Intersection Spacing	
		Same side of road or 4 way	Opposite side of road
Local Collector or Local Access	Yes	60m	40m
District Collector	Limited	100m	60m
Sub Arterial	No	250m	100m
Arterial	No	350m	150m

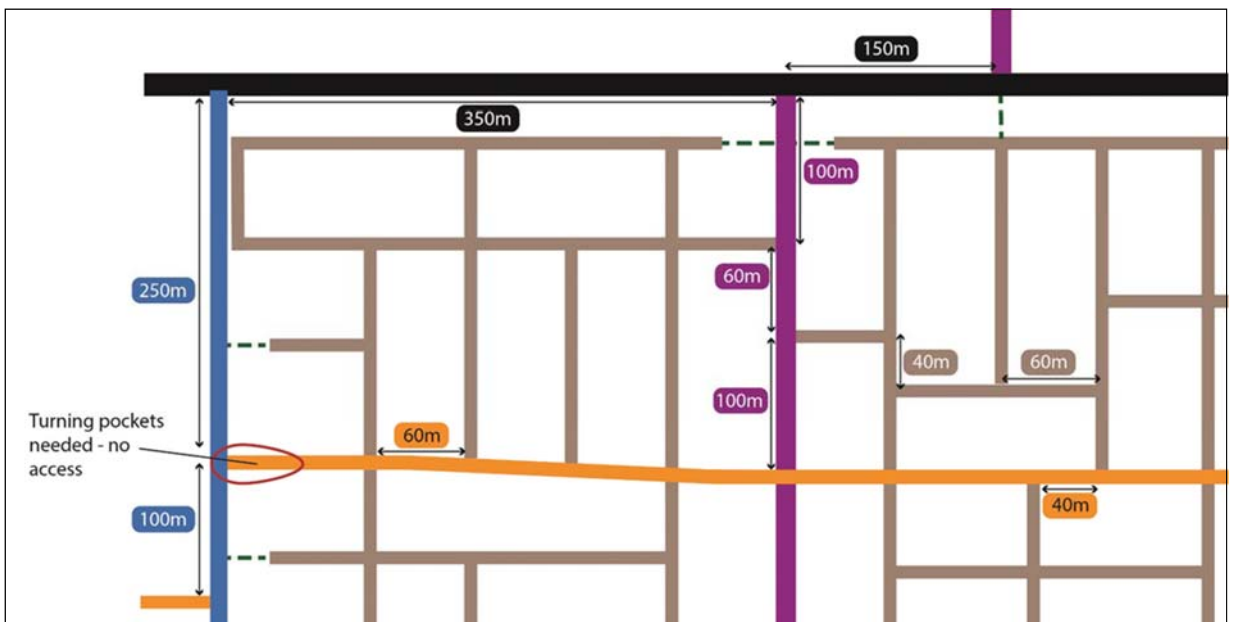
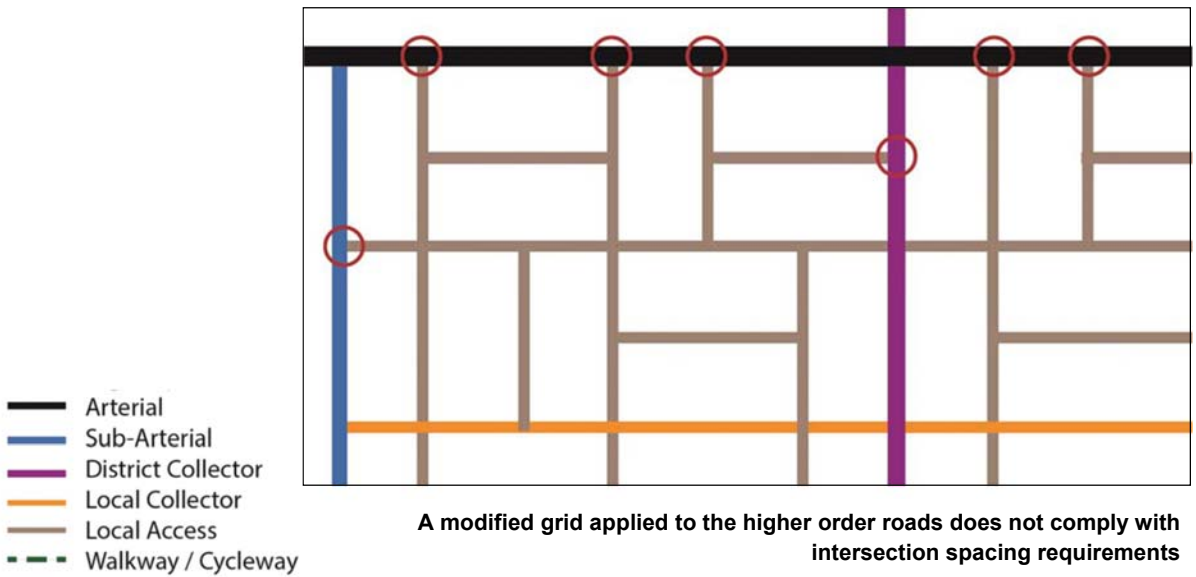

Four Way Intersections

Four way intersections are an important component of the urban street network. They reduce traffic speeds and make it easier for people to find their way around the neighbourhood.

A grid system can be a mix of 3 and 4 way intersections (known as a modified grid). It should provide a mixture of direct streets for easy way-finding and direct local journeys, and short streets.

Limited use of Cul-de-sacs

Cul-de-sacs are not a preferred form of development but may be used on occasion as part of a layout that is mostly connected. The use of cul-de-sacs may include reaching an awkward corner of a site or to create a pedestrian only link onto a higher order road (avoiding a four way intersection).

Where cul-de-sacs are used to reach an awkward corner of the site, this should be limited in length and only be where other solutions are not viable

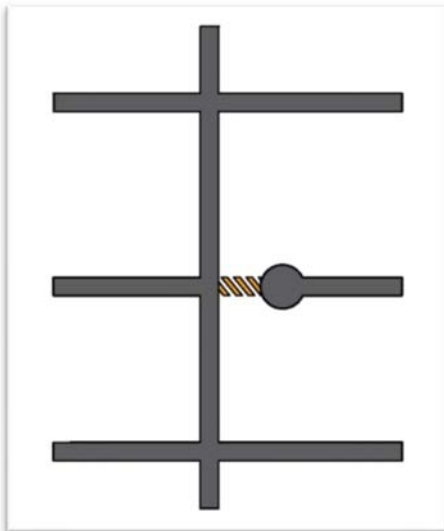

Intersection Type and Spacing

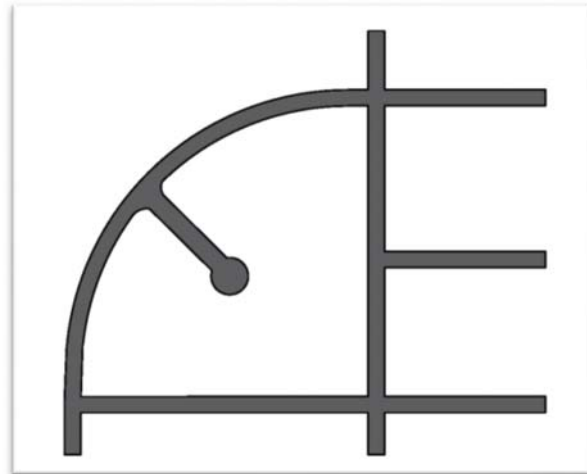

Limited length of Cul-de-sacs

9 Orientation of Streets

For solar access

The best solar access will occur if streets are aligned approximately east-west and this should be the main orientation where possible. Streets that are aligned north-south should generally be the short side of the block. Other orientations should be minimised where possible but may be used to fit in with other design aims.

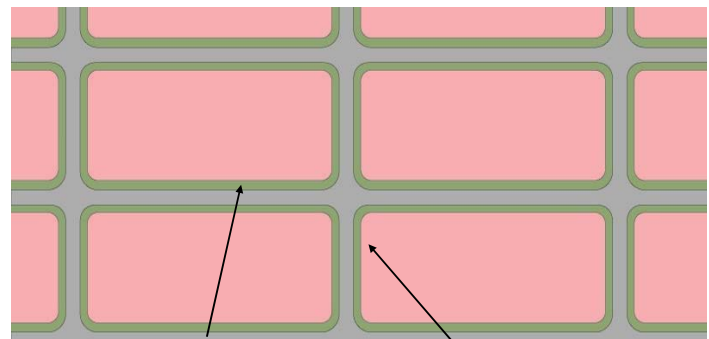

Best solar orientation for houses is on east-west streets

Short side of grid on north-south roads

Solar Orientation

To complement a frame road or provide direct access to focal point

Sometimes a frame road will run through the development. These may be oriented to provide direct connections to neighbourhood hubs, public transport, parks or other focal points and buses may run down these roads. Because of this, these roads may not be oriented east west or north south and this may disrupt the grid.

If the grid is focussed on a station or neighbourhood hub, then this may also disrupt the orientation. The radiant grid in section 6.1 is an example of this.



Block orientation to provide access to frame road (e.g. district collector)

To Manage the number of four way intersections

Four way intersections provide legibility and reduce traffic speeds. They are an important component of residential design.

However, it is sometimes appropriate to reduce the number of 4-way intersections, especially for busy roads. One way to do this is to rotate some parts of the grid through 90 degrees.

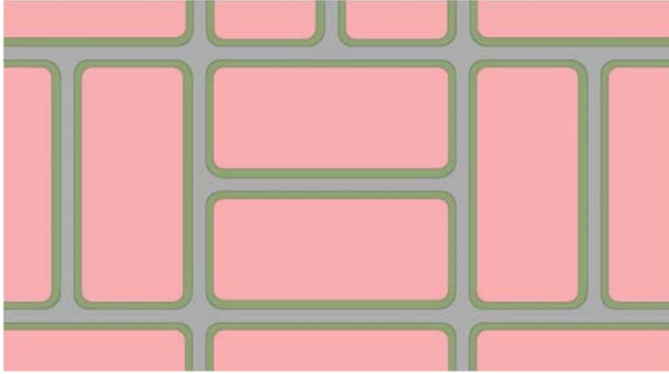

Some Blocks rotated to reduce 4 way intersections

To respond to topography

Topography is often the driver of street layouts and will always have some significance. Grid patterns may be distorted because of the constraints imposed by slopes. However, the need for a connected grid-based network remains, and grid blocks should still conform to a maximum walkable perimeter (as specified in the Reconfiguring a lot code).



Grid orientation to suit topography

10 Limited Access Streets

On local streets vehicle access will always be directly from the street. For arterials houses may back onto the street.

For collector roads and sub-arterials, some judgement is needed. Where direct access is not possible, the following may be used. The best result may be a combination of solutions along the length of the street:

All Zones & Precincts	Refer to PSP Integrated Design Appendix 1
-----------------------	---

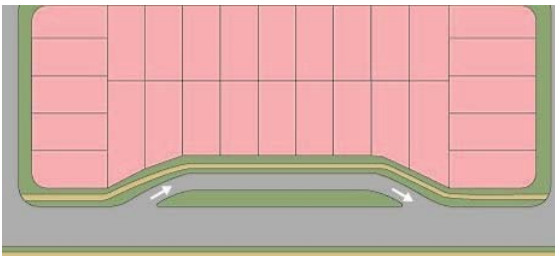
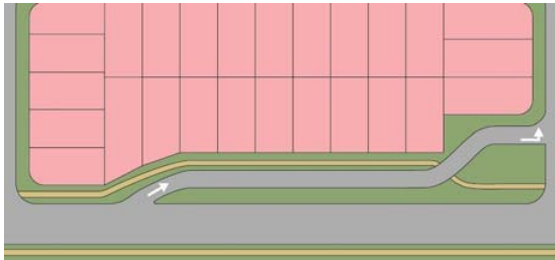

One-way service road



Use of a service road (North Lakes)

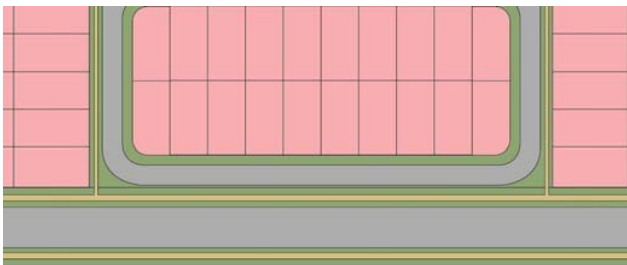

Service road from behind

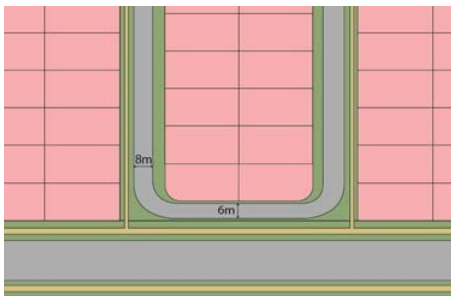

Local streets connected by laneway

Limited Access Streets (cont)

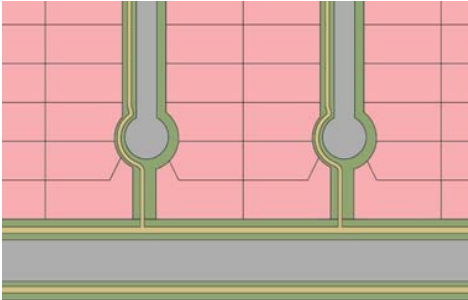

Cul-de-sacs with houses side onto the major road

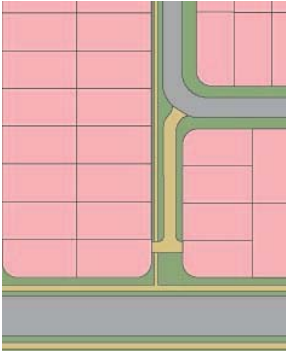

Combined access and pedestrian / cycling connection



Combined access and walkway (Caloundra West)

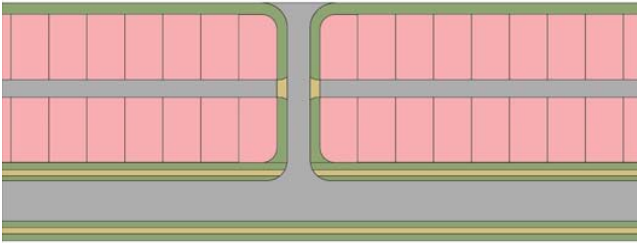

Rear Lanes



Rear Lanes next to collector road (Fitzgibbon Chase)

Houses Backing on to Roads

Houses may back onto arterial roads but should not back onto collector roads or sub-arterials.

The use of transparent fencing is not appropriate mitigation next to busy streets as it compromises the privacy of residents and tends to be fenced.

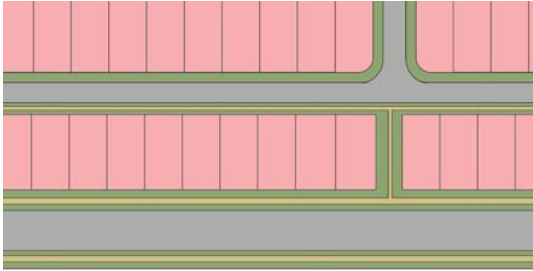

Arterial only - Backing onto road



Houses backing an arterial road with landscaping (Caboolture)

Use of Laneways

Rear lanes are useful to minimise the impact of driveways and vehicle access on the street where high density freehold lots are proposed.

The provision of on-street parking at the front of the house is important where laneways are used. The rear lane should be easily accessible from the front of the house (access should not involve convoluted journeys).

In residential areas, laneways are a good solution in the following circumstances:

- As a way to avoid front access on limited access roads
- Where houses are opposite a local or district park

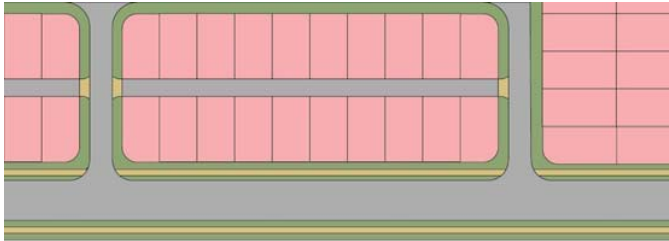

Straight Laneway

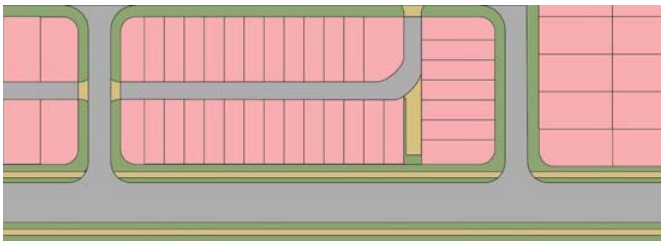

Curved laneway must allow for rubbish truck turning

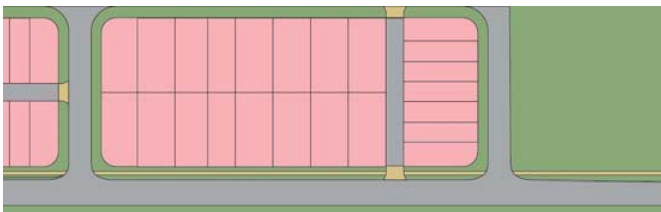

Single sided block-end laneway

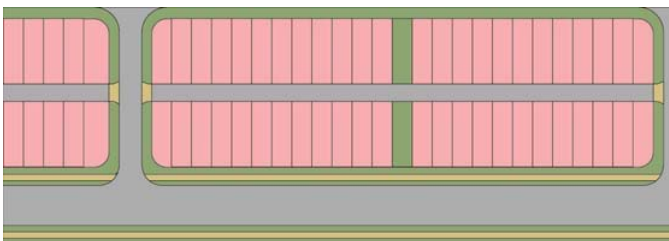

Longer laneways must allow pedestrian access mid-way



**Laneway Houses (Front and Rear)
(Fitzgibbon Chase)**

11 Street Layout and Design

The diagram opposite illustrates a connected street network designed in accordance with the Moreton Bay Regional Council Planning Scheme. The diagram is designed to show:

- How the different types of streets create logical connections through the neighbourhood
- The way lower order roads connect to the major road network
- Options for fronting higher order roads with no direct road access

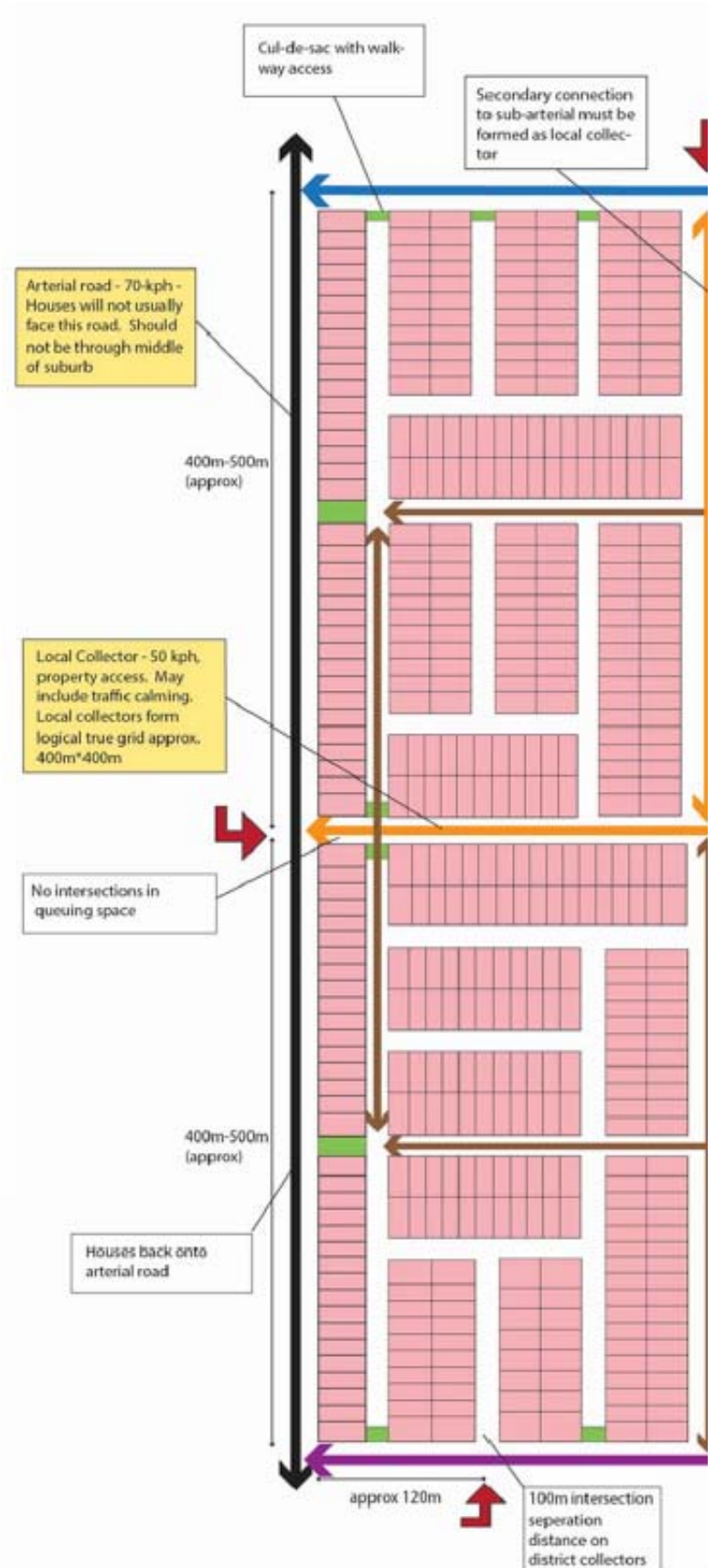



12 Open Spaces

Open spaces include Local, District and Regional Parks, linear parks, stormwater treatment areas and the Green Infrastructure Network. Together, these spaces contribute character, distinctiveness and natural beauty to a neighbourhood.

12.1 Parks

In assessing the need for parks, the following needs to be considered:

- 1 Future (forecast needs for open space).
- 2 Existing public space in and around the development area.
- 3 Any masterplanning or structure planning that has taken place for the area.
- 4 The need for linear parks or other connections.

Parks should be located to:

- Maximise the number of people within a 5 minute walk (400metres) of a park**
- Maximise the wider benefits of the park including:**
 - Its position as a connection (a place people walk through on their way to a focal point).
 - Co-location with adjoining stormwater management areas
 - Retention of existing vegetation

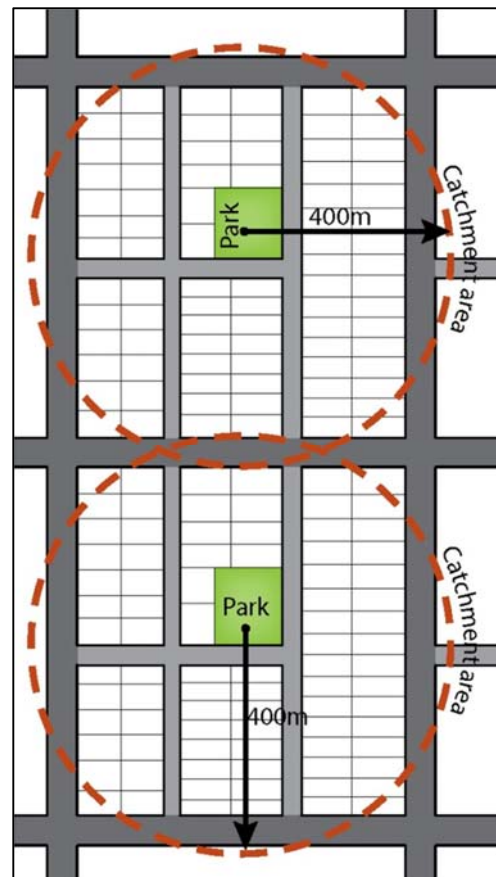

Maximising the number of people within 400m of a park

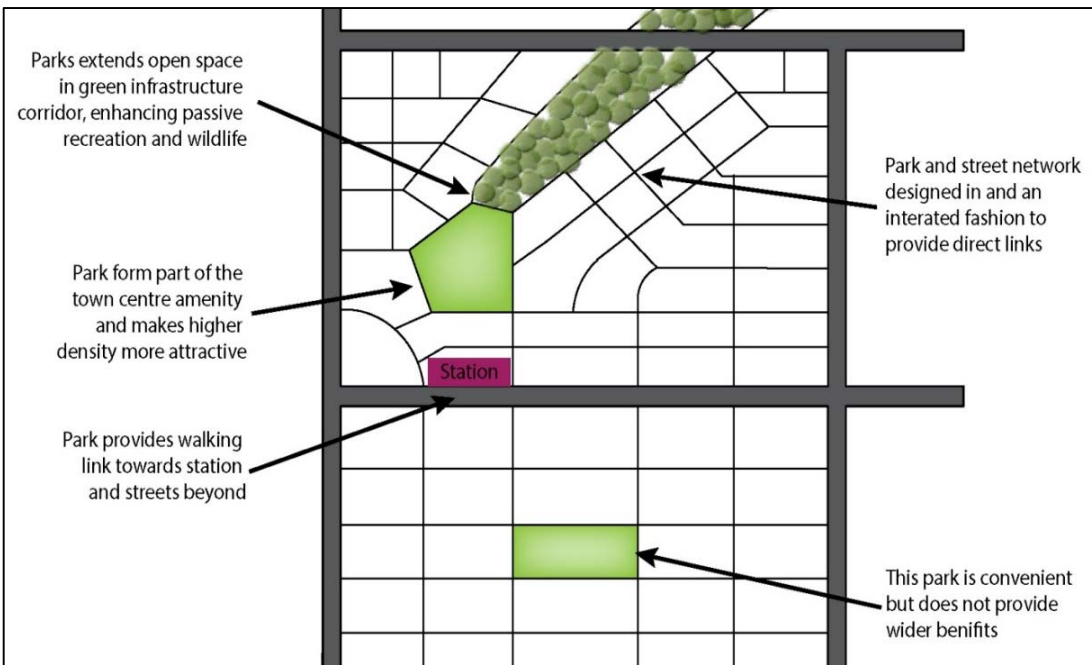

Maximise the wider benefits of a park

iii. Take advantage of Topography

In a subtropical climate, ridgelines and higher ground are the ideal location for pedestrian connections to take advantage of breezes and views.

iv. Be Overlooked by Windows and Built Frontage

Parks should be directly overlooked by houses or commercial / retail buildings over the majority of the perimeter of the park. This may be directly (e.g. where accessed by a rear lane) or across the street.

v. Be Integrated with Centres

Where a neighbourhood includes a local centre, the centre should be integrated with open space if possible. The open space may take the form of:

a) A local park co-located with the centre

Where parks are co-located, the centre and park should function as a single destination by including the following elements:

- Integrated car parking that serves both destinations
- Commercial buildings face the park directly, possibly across a road

b) A civic plaza integrated with the centre

A civic plaza is a small, more formal public space integrated directly with a commercial development, usually in the form of a town square. The civic plaza will be designed at the time of the development to:

- Be faced by active frontage on at least one side (not across a road)
- Be located as an entrance feature, inviting people to walk through it on the way to the centre
- Be located adjacent to the main entrance to the shops

- Direct integration of facilities where possible (e.g. café seating spills out into the park and overlooks the playground)



A Highly visible park integrated with its surroundings (North Lakes

12.2 Stormwater

Locate stormwater management areas to increase the amount of open space in the development or to achieve ecological aims. Some ideas for achieving this are:

- As a feature next to a park, to create a larger open space:
- Integrated with the Green Infrastructure Network
- Raingardens and planted swales within the road corridor

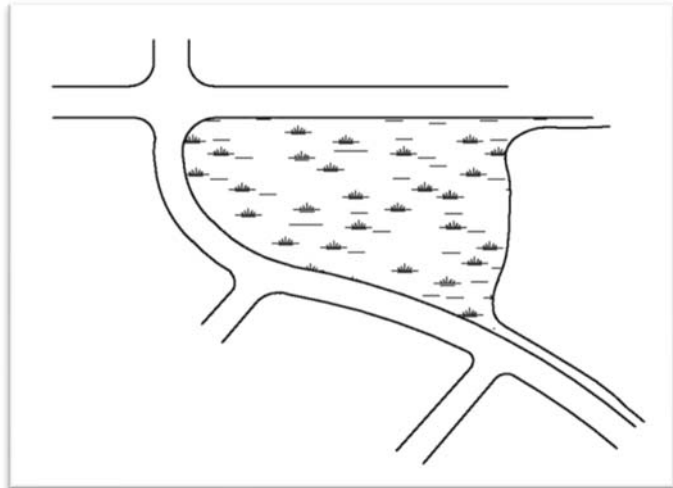
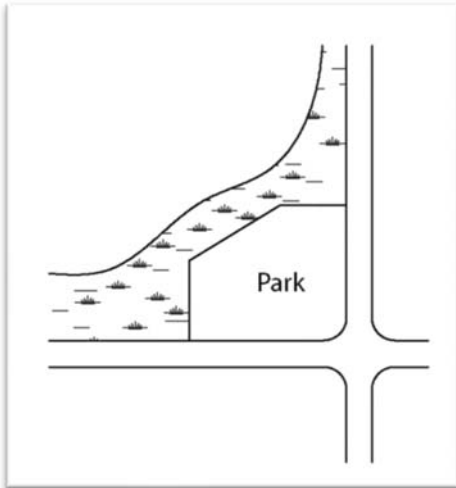

Stormwater Locations



12.3 Green Infrastructure Network

Green infrastructure is a network of natural, semi-natural and engineered green assets that are functionally connected across a landscape. A green infrastructure network contains areas and corridors of natural bushland, parkland, street and habitat trees, urban landscaping, permeable paving and even innovative design technologies including green roofs and walls.

The Green Infrastructure Network is both a constraint and an opportunity. It should be considered at an early stage so that:

- the existing natural values of the site can be incorporated into the network.
- to maximise the amenity provided by the GIN.

The aim is to create a functional and connected network for wildlife movement. With this in mind, the design and layout of development should respond to the site. For instance roads may be positioned to incorporate existing trees into the road reserve.

Forming a Connection

A connected network should be formed from existing and new elements. Green infrastructure elements such as street trees can be used to connect areas of natural bush.

Local roads should be positioned at the edges of natural bushland areas to provide amenity to the neighbourhood. Locating parks next to the GIN will maximise the amenity benefits it provides and, if appropriate trees are planted in the park, improve the habitat for wildlife.

Where possible, major roads (i.e. District collector and above) should not be placed next to the GIN because of the danger they pose to wildlife. It will sometimes be necessary to connect roads through the GIN but these connections should not be too frequent. The use of wildlife movement infrastructure will sometimes be necessary, for instance to funnel wildlife movement under busier roads.

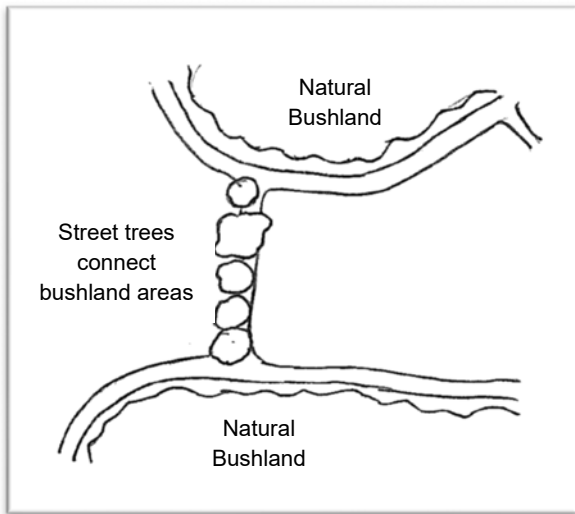
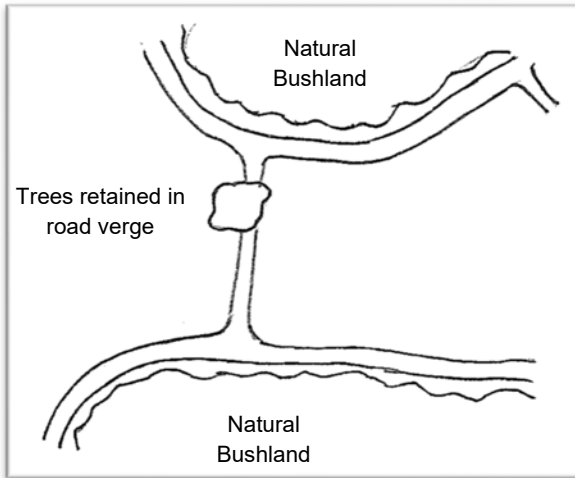

Connecting the Green Infrastructure Network



Koala Movement

Where koalas and other wildlife are using trees in urban areas, neighbourhoods must be designed to retain and promote safe and ongoing koala movement and habitat values. Sometimes koala movement patterns can be incorporated into street networks to build safer road networks for wildlife.

Creating and retaining trees and linkages of native trees will assist koalas and other animals to move safely through the landscape. For example, scattered gum trees along road reserves, in civic spaces, open space parkland and drainage reserves promotes safe wildlife movement by providing 'stepping stone' food and habitat resources. Retained trees should be supplemented with new ones to create safe movement routes

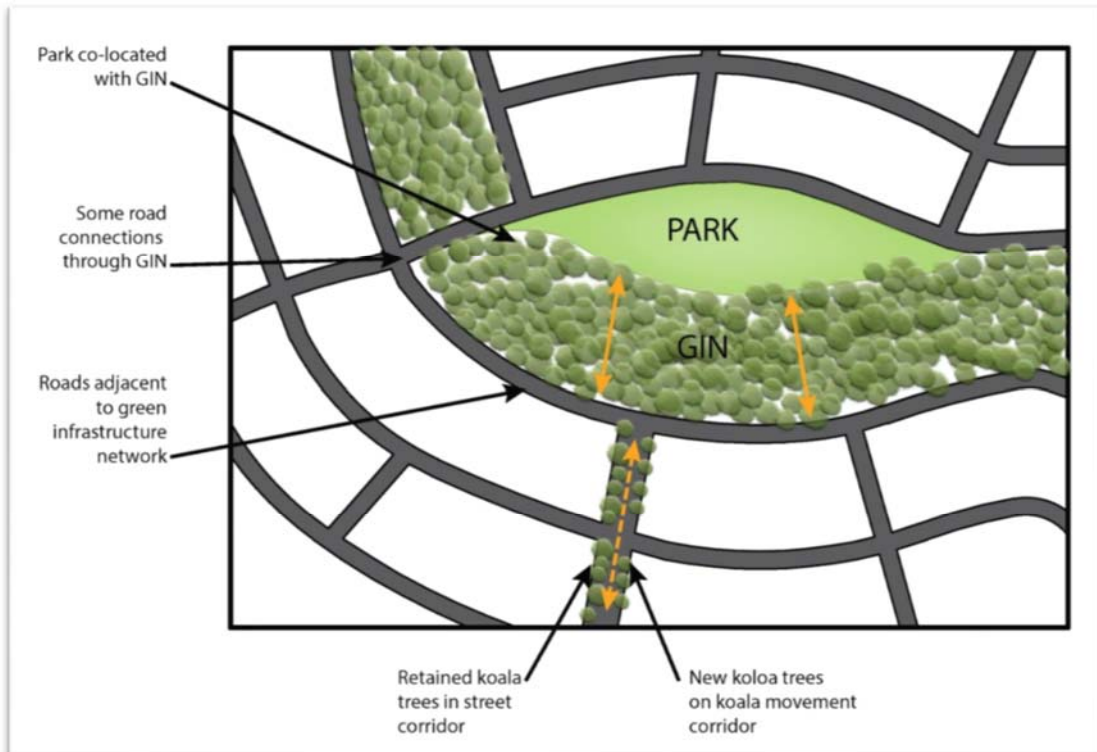

Koala Movement

13 Centres

New centres must be designed as part of the neighbourhood. This means that suitable land should be set aside at first design stage that can serve as an attractive, walkable focal point for the neighbourhood. A land parcel suitable for a centre should:

- Have dimensions that allow shops to face the street directly
- Be integrated with parks where possible
- Be located adjacent to busier streets
- Allow the provision of car parking and access in a way that is not dominant (usually it will be to the side and rear).
- Be accessible from all directions
- Take advantage of any other local opportunities, such as linear parks providing good walking access.

The surrounding area should be designed to allow access to the centre, especially on foot and by bicycle.

This could mean:

- Orienting streets to focus on the centre
- Ensuring that walking routes to the centre are not blocked by earlier stages of development

Where there is an existing centre that would serve the development, consideration must be given to how it will be accessed from the area.

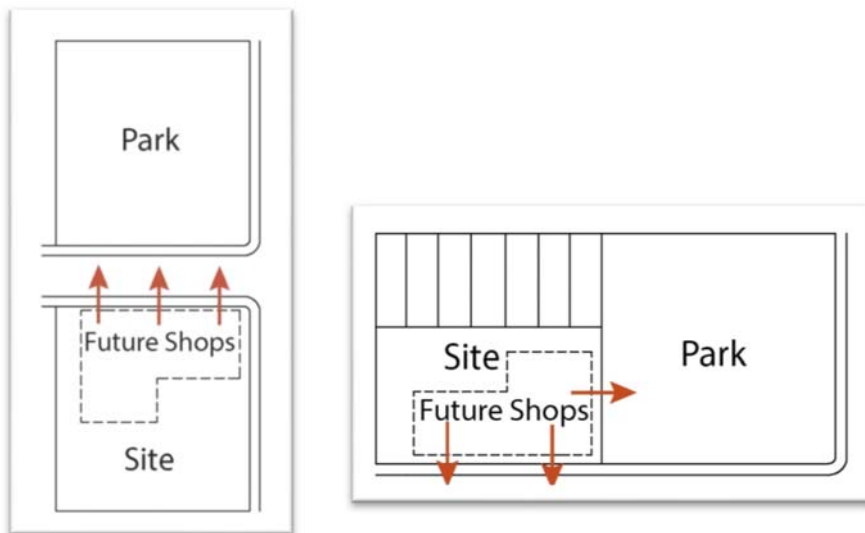

Examples of commercial sites co-located with parks

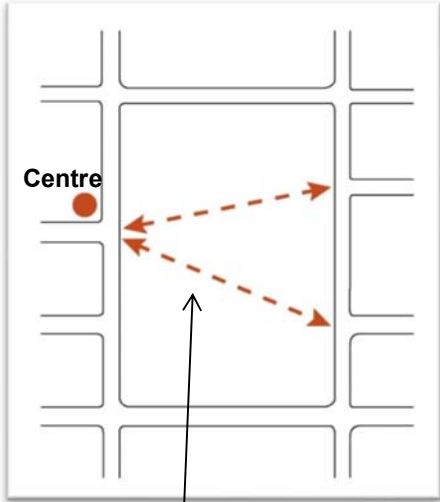

Desire lines cross the development site diagonally

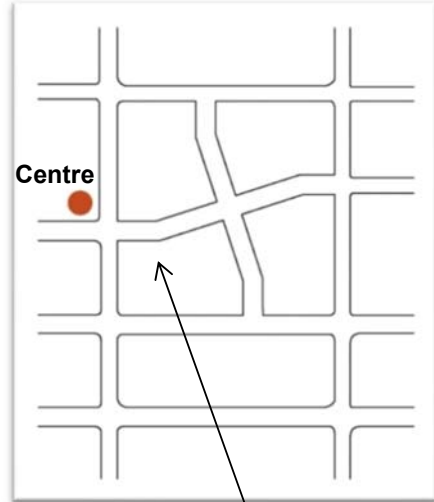

Desire lines catered for in development
Desire Lines and Accessibility

14 On-Street Parking

All Zones & Precincts Refer to PSP Integrated Design Appendix 1

On-street parking requirements are specified in the Works Code and Planning Scheme Policy - Integrated Design as follows:

- Frontage of less than 12.5m: 0.5 spaces per lot
- Frontage of more than 12.5m: 1 space per lot

The examples below show how this is applied in the next generation and urban precincts.

Next Generation Precinct

The example below provides 107 on-street parking spaces. This easily meets the requirement for 51 spaces as shown in the table:



Lots	Lot Count	On-Street Parking Required
<12.5m Frontage	65	32.5
>12.5m	18	18
Total	83	51

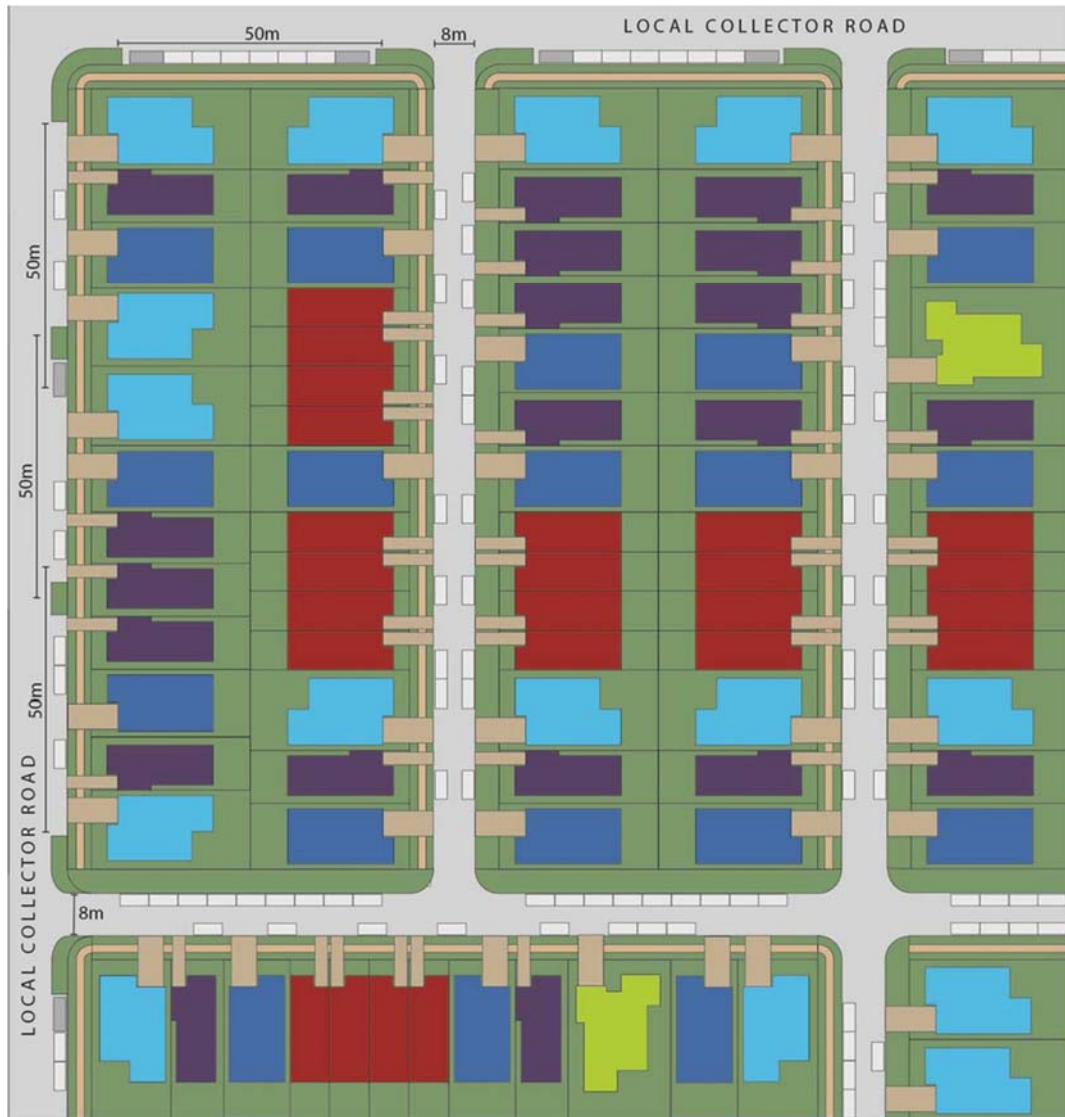

Parking Diagram: Next Generation Precinct

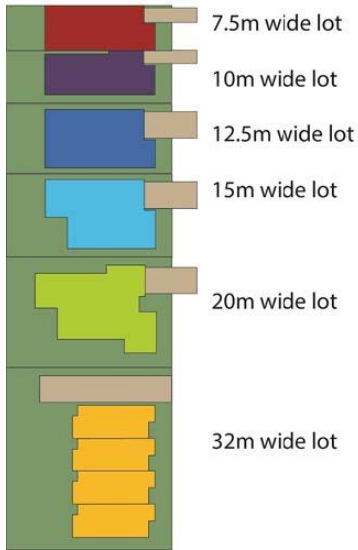

Urban Precinct

This example has 86 on-street parking spaces for 92 lots and easily meets the requirement overall.

It is notable how much more parking is available in street A (with a rear lane - 19 spaces) compared to street B (without - 7 spaces).

Lots	Lot Count	On-Street Parking Required
<12.5m Frontage	89	44.5
>12.5m	3	3
Total	92	48



Parking Diagram: Urban Precinct

15 Transitions between Precincts and Zones

There are sometimes challenges in locating different activities or densities next to each other. This may include shops next to residential uses or the boundary between urban and next generation precincts.

15.1 Next Generation to Urban

Where Next Generation Precincts transition to urban precincts, or where there are adjacent sub-precincts with different height limits, the best place for the change in precincts is at the road frontage.

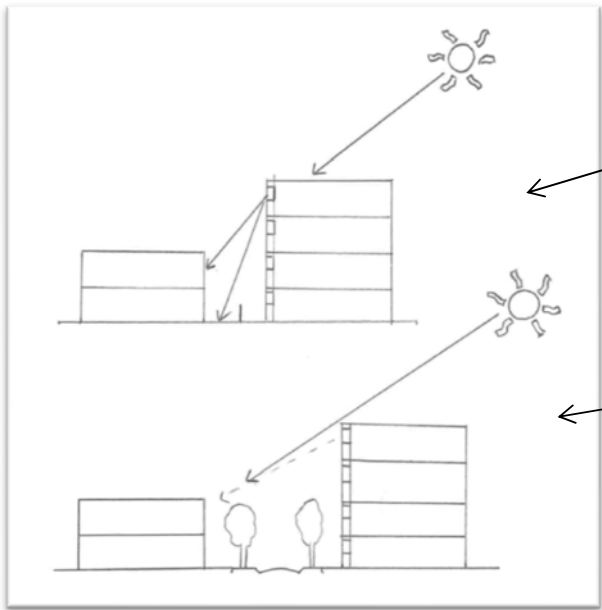

Overshadowing and overlooking of private space from taller buildings is not expected in precincts like Next Generation neighbourhoods.

In this example there is more separation between windows and balconies and private rear garden space is not overlooked.

15.2 Neighbourhood Hubs

Where there is a neighbourhood hub, the aim is to create an active retail presence. Designing a neighbourhood structure with a neighbourhood centre enclosed in a single block will usually mean that the back of shops (with servicing and bins) faces the street at the back. Often, the best outcome is to change the precinct within the block. This is especially true for small centres where deliveries are less intrusive.

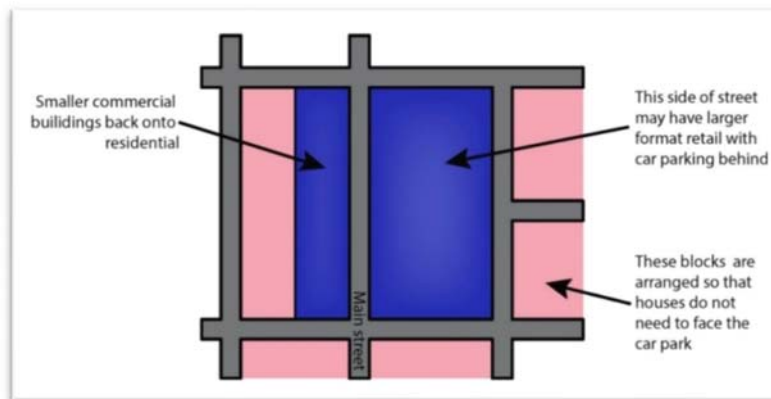

A photograph of a modern industrial building. The building features a white facade with a prominent, angular, cantilevered section. To the left, a portion of the building is painted a vibrant red. Large, rectangular windows are set into the white facade, some of which are illuminated from within. To the right, a glass curtain wall reflects the sky. The building is surrounded by lush green landscaping, including several young trees and dense shrubs. A paved walkway is visible in the foreground. The sky is a clear, pale blue.

PART 3

INDUSTRIAL AREAS

16 Enterprise and Employment Areas

16.1 Purpose and Character

This section refers to the Enterprise and Employment Place Types, including the Mixed Industry and Business Precinct as well as a variety of Industrial Zones from Light Industrial to Restricted. The purpose of the different precincts is summarised below:



Precinct	Purpose
Mixed Industrial and Business Area (MIBA)	Employment intensive, low impact industrial activities, with a high standard of visual amenity and high quality urban form. May include associated commercial activity.
Light Industrial Precinct	Low intensity and scale industry with limited off site impacts. May include industrial activities which generate visits from the general public. High standard of amenity.
General Industrial Precinct	Medium intensity and scale industry. Adverse impacts do not affect people outside the zone (or a zone buffer). Very limited non-industrial use.
Restricted Industrial Precinct	High impact industrial with adverse effects that must be separated from the rest of the urban area.
Marine Industrial Precinct	Port services, marine industry and related activities only.

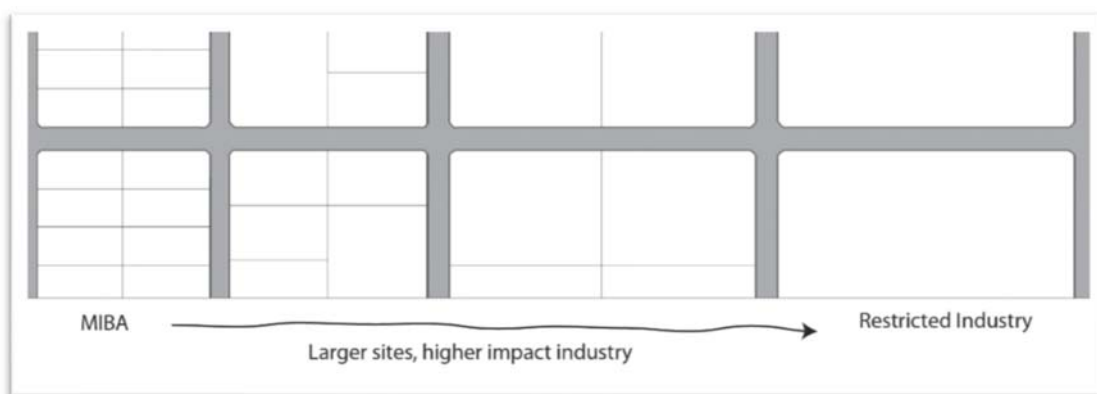

Form and Function of Different Precincts in the Industrial Zone

Industrial areas have a different character to residential. There is still a need to move easily through them and they need to be pleasant places. However, depending on the type of industrial, there is a change in priority from a place that is attractive to one that is more functional. Through the different industrial precincts, with an increasing degree of industrial intensity, there is a change in emphasis from high amenity and high connectivity to larger sites, less connectivity and more functional design.

16.2 Location

Industrial zones will be located on major transport corridors.

There will usually be some degree of separation between industrial areas and the rest of the urban area. The importance of this depends on the intensity of the industrial use. MIBA, Light and Marine Industrial areas may contain businesses open to the general public, attracting more visitors than other industrial precincts. These areas need to be accessible and well integrated into the urban structure.

General and Restricted Industry are for more specialised industrial uses with few casual visitors and the need for a high degree of accessibility is less.

There is a need to manage this balance between the area being accessible, and managing the adverse effects it may create, particularly heavy vehicle traffic. Main road access should not be through residential areas, but there may be local road access to MIBA and light industrial.

The best way to achieve separation is through the use of use of natural barriers like roads, drainage and the Green Infrastructure Network to create separation. Paths, either walking and cycling or access roads, can be provided where appropriate:

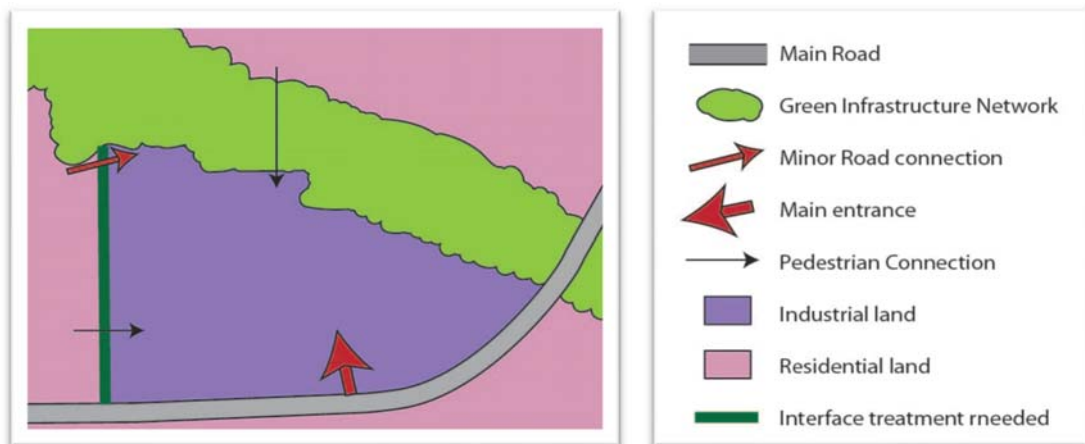

Relationship of industrial land to its surroundings



16.3 Structure

Industrial zones should be part of the urban structure. They will be permeable and connected. They will have local facilities (such as local shops and cafes) located centrally where they are accessible within the industrial area. These hubs will be co-located with open space on main routes through the area.

Like residential neighbourhoods, industrial areas will be built with a grid connected road network, so they are easy to navigate and can be accessed on foot or by means of active transport.

Using some 4-Way intersections helps to make a place navigable, especially if routes converge in a central place. This is often the best place for facilities like the neighbourhood hub.

Due to the scale of industrial activities and the lower intensity of use anticipated, the grid size expected is larger through the different types of industrial use.

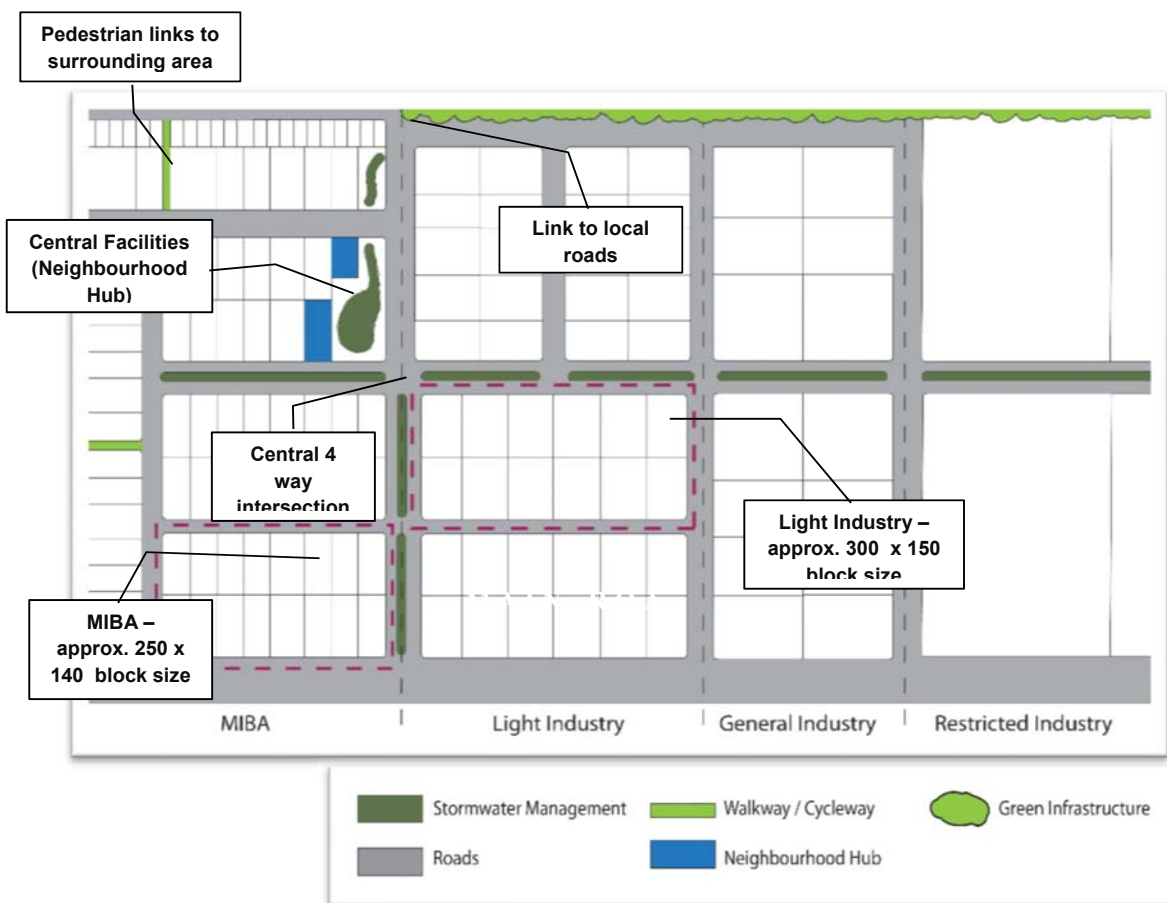

Structure of Industrial Areas

16.4 Movement

Walking and Cycling

Walking routes will be provided through industrial areas on the street network. The block structure of the network will ensure that there is good pedestrian access throughout. Blocks should not generally have a perimeter greater than 1km except for Restricted Industry.

Street trees and landscaping within the street corridors will provide shade and amenity to make walking a viable option.

Public Transport

Public transport should be available within 400m of the majority of sites. This may be within adjacent roads, or on an internal road. Public transport should follow logical routes that are reasonably direct. Buses should not have to double back on themselves or follow convoluted paths.

Connections to main roads

All industrial areas should be directly connected to the main road network. There may be connections to the local road network – however these should not be more attractive for heavy vehicles than the route to the main road (for instance by connecting directly to an alternative main road).

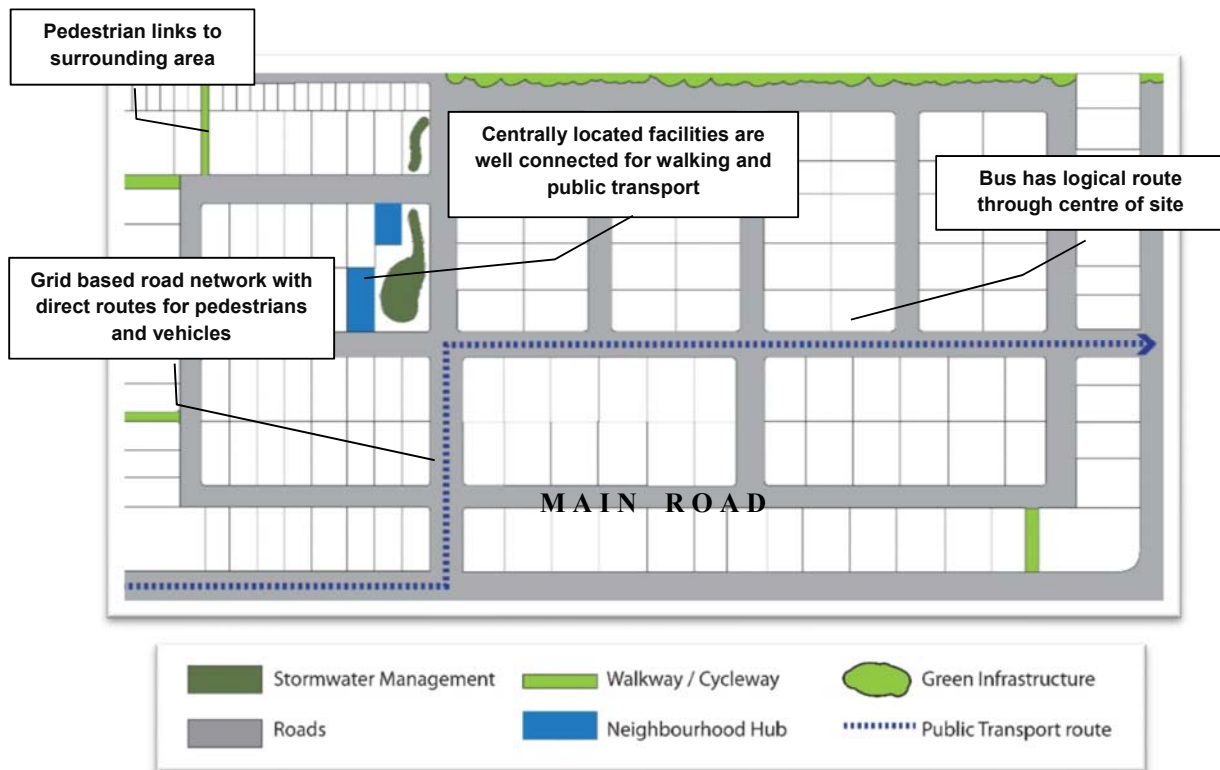

16.5 Stormwater

Design and locate stormwater management areas to provide some amenity to the area. Planted stormwater areas with trees add interest to the area and reduce the dominance of hard-surface and large scale buildings.

Stormwater management may be on site or in dedicated areas. Either way, it should be open and planted to provide visual amenity. An integrated approach is preferred to site by site solutions. Multiple properties can be served by larger detention basins.

Some areas may be suitable for raingardens and these are an opportunity to enhance the street amenity, especially in higher amenity industry areas such as MIBA.

Some ideas for the location of stormwater areas are:

- As a central feature or landmark at a prominent junction.
- Next to a road or walkway as a linear feature.
- Next to and integrated with the Green Infrastructure Network.
- Raingardens and planted swales in the road corridor (centrally located swales are preferred, especially in areas other than MIBA).

16.6 Open Space and Facilities

MIBA and Light Industrial areas will include local shops and facilities to serve the people who work in the area. These are known as neighbourhood hubs. They serve as focal points for the area and must be:

- Conveniently located for people within the area, easily accessible on foot from all directions and by public transport (if provided within the area).
- Located next to busier streets.
- High amenity areas, including some public space and taking advantage of opportunities to improve amenity such as stormwater corridors or remnant vegetation.

Suitable land for a neighbourhood hub should be set aside at the design stage.

The surrounding area should be designed to allow access to the centre especially on foot or by bicycle. This could mean:

- Orienting streets to focus on the centre.
- Ensuring walking routes to the centre are not blocked by earlier stages of development.
- Locating smaller blocks and smaller development parcels around the centre.

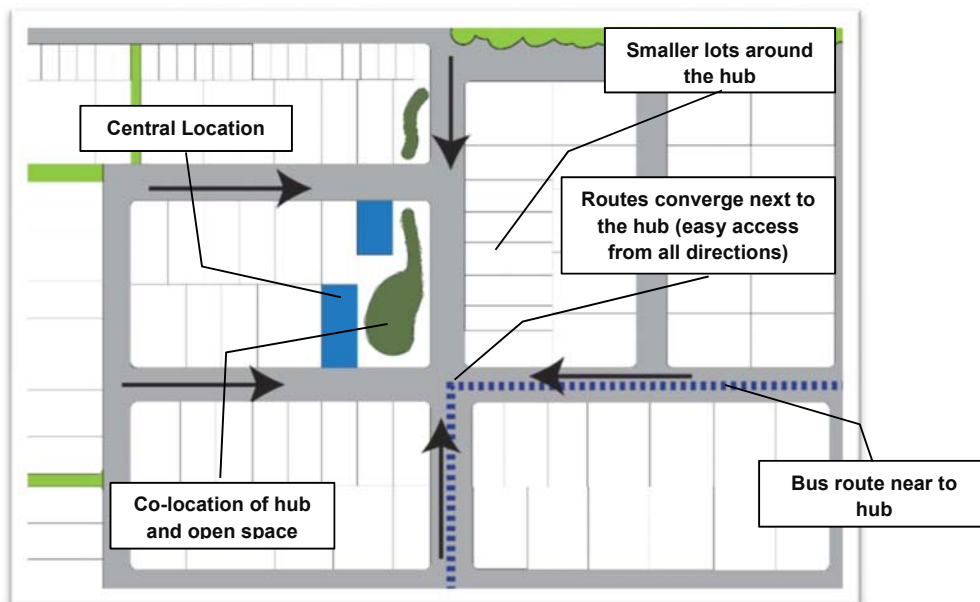

Structure of Industrial Areas

16.7 Retention of High Value Vegetation

High value vegetation must be retained and integrated into the design of the development. Keeping this vegetation will make the area more attractive and distinctive as well as maintaining ecosystem services. It will also provide shade and assist in stormwater management.

Retained vegetation should be incorporated into the public realm, for example co-located with stormwater management or road corridors.

The development should also connect the retained vegetation to any surrounding vegetation through the use of green corridors where possible, to allow wildlife to reach it. This can be achieved through the planting of suitable street trees or trees within stormwater management areas.

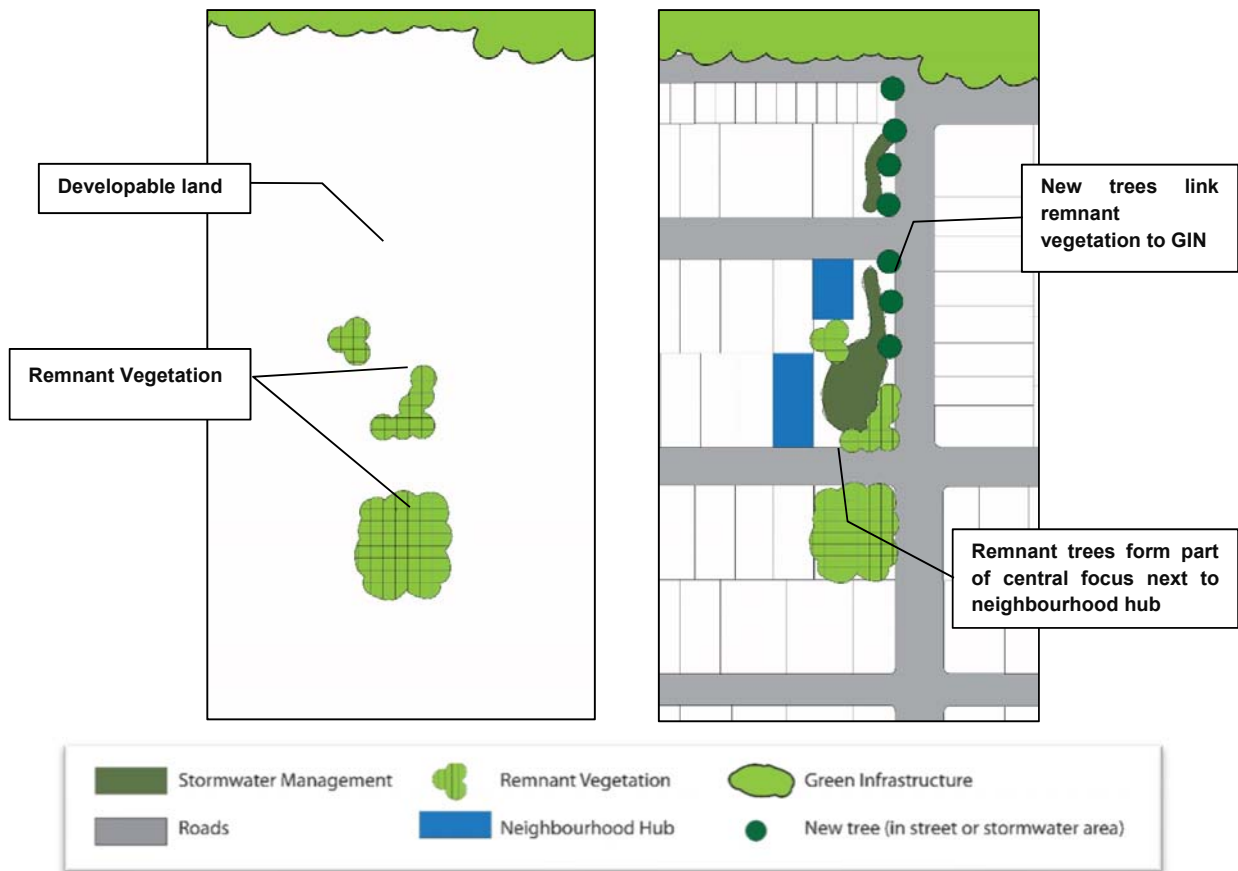

Designing for Remnant Vegetation and Wildlife

16.8 Transitions to Other Zones

Industrial zones generate adverse environmental impacts which can affect land and people around them. The transition to neighbouring areas must be considered carefully.

The best transition is where there is a natural barrier such as a main road or stormwater or environmental corridor. This manages the effects by providing a degree of separation.

The need for separation is not so great for MIBA and light industrial areas that create fewer of these effects and can provide a location for goods and services used by people from the nearby towns. Where there is a boundary between these precincts and other urban area zones it should be managed by:

- Reducing the scale of buildings near the zone boundary, possibly by placing smaller lots in this area.
- A degree of separation so the dominance of blank walls and large scale buildings is reduced.
- Planting trees and bushy shrubs within the separation area.

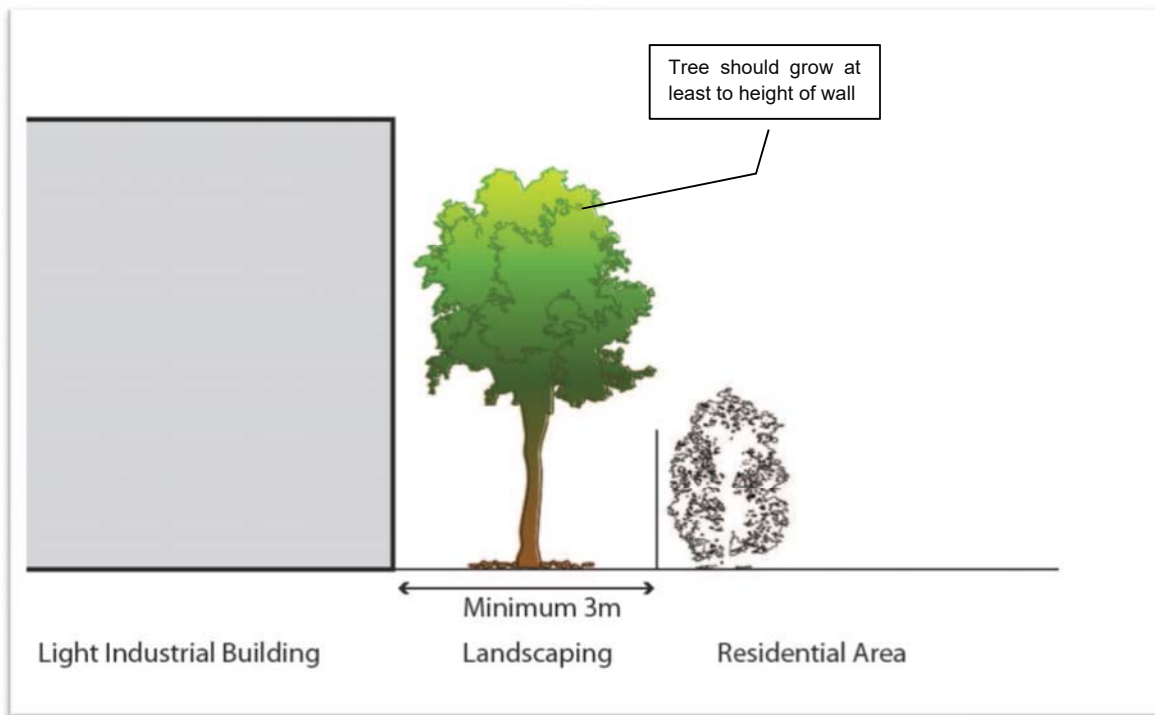

Transition from MIBA / Light Industrial to other zones

End Notes

Amendment Number: 2 Adopted: 27 June 2017 Effective from: 3 July 2017	
Planning Scheme Policy Reference	Summary of amendment
-	<ul style="list-style-type: none"> Amendment to reflect the terminology used in the <i>Planning Act 2016</i>, the <i>Planning Regulation 2017</i> and related state planning instruments.
Amendment Number: 3 Adopted: 12 December 2019 Effective from: 29 January 2020	
Planning Scheme Policy Reference	Summary of amendment
-	<ul style="list-style-type: none"> The overall purpose and general effect of the adopted amendments to the existing planning scheme policies are to respond to changes to the reconfiguring a lot code and to align with the general structure of that code; to expand on the need to plan for and maintain continuity of movement networks; to provide direction on how to appropriately deal with interfaces; and to provide additional guidance generally.